



# Warehouse safety manual

Use, inspection and maintenance of  
Live Pallet Racks and the Push-back system



# Summary

## A MANUAL OUTLINING THE USE AND MAINTENANCE OF LIVE PALLET RACKING AND THE PUSH-BACK SYSTEM

3	<b>Introduction</b>
4	<b>Key warehouse components</b>
4	Unit loads
5	Slabs or floors
6	Handling equipment
7	Storage systems
8	<b>Live pallet racks</b>
10	<b>Pallet racks for a Push-back system</b>
13	<b>Using your racks and handling equipment</b>
13	Unit loads
15	Forklifts
19	Live pallet racks
23	Pallet racking for a Push-back system
26	<b>Inspection and maintenance</b>
26	Inspecting your storage system
28	Maintenance guidelines
28	Inspecting frames
30	Inspecting racks
31	Inspecting beams
31	Inspecting locking systems, rollers and carriages
33	Assembly tolerances
34	Inspecting floors and aisles
35	Inspecting unit loads
37	Inspecting handling equipment
38	Other considerations
39	Safety checklist

# Introduction

All warehouses in operation hold productivity and working conditions as universally important concepts. That is why safety must come first in the day to day usage of your racking system. Safe, strictly observed warehouse practices will keep personnel entrusted with working for a company from being at risk.

The focus of this manual is installations where unit loads, generally palletised or in containers, are transported by forklifts or other handling equipment. It does not address the risks involved with the manual loading of goods.

A well-maintained pallet rack warehouse will facilitate all work in progress. However, misuse of any part of the storage system may cause an accident.

A warehouse includes these principal elements:

- The slab or floor,
- Unit loads,
- Handling equipment,
- Racks.

To prevent possibly dangerous situations –where personnel could get hurt, or there could be costly stops in service and damage to the installations or goods–, the following measures should be taken:

- **Prevention:** train personnel to use the installation and equipment properly.
- **Inspection:** have ongoing checks by personnel to make sure everything stays in top condition.
- **Maintenance:** if there is a defective or malfunctioning warehouse component, it must be fixed or replaced immediately.

The safe, sound use of an installation is achieved through the collaboration of the users and the racking and handling equipment manufacturers.

## Please note!

Responsibility for the surveillance, use and condition of the installation lies with the customer. The customer must convey the content of these manuals to those in charge of the warehouse and to warehouse users.

This manual is based on the guidelines found in the EN 15635 standard.

The user must also comply with the specific standards for this type of installation in force in each country.



Push-back system



Live pallet racks

The Mecalux Group has put this manual together to guide its customers on how to use a racking system correctly. Its contents are based on the diverse recommendations from European agencies in this sector (FEM, INRS), the EN 15635 standard (Steel Static Storage Systems. Application and maintenance of storage equipment.), technical notes on prevention from the NTP (the Spanish National Institute of Workplace Safety and Hygiene), and more than 50 years of experience in the warehousing sector.

As such, this manual should be read carefully, and its recommendations applied. The Mecalux Group is on hand to answer any questions installation users may have on the subject.

---

## Key warehouse components

### Unit loads

Unit loads are determined by the product to be stored and any additional elements required to move and store this product (pallets and containers).

These bases have different shapes and are made of different types of materials:

- Wooden pallets
- Metal or plastic pallets

The construction of these bases must comply with the following requirements:

- The specifications found in ISO, EN and UNE standards.
- The ability to withstand the deposited load.
- The model is suited to the installation's planned design.

Special considerations must be taken into account when providing load storage on plastic or metal bases and containers. These considerations must be clearly identified and firmly established prior to the installation's design. Additional measures might well be necessary, which may result in higher system maintenance at the installation.



Wooden pallet



Metal or plastic pallet

Both the weight and maximum dimensions of the palletised loads must be predetermined. The system can then operate correctly, in terms of strength and clearances. Unit loads can take on different shapes once goods have been placed on the pallet.



Fully covered and aligned



Overhanging and centred



Fanned



Bowed

## Slab or floor

A slab is a basic structural component for operating a warehouse, which is determined and constructed as per the following:

- **Characteristics such as stability and strength**, which must withstand the loads transmitted by the racks and the handling equipment. As a minimum, the concrete must be of C20/25 quality (according to EN 1992), with a minimum strength of 20 N/mm<sup>2</sup>;
- **The planimetry or levelling of the slab or floor**, which must be done according to the specifications found in the EN 15620 standard.

Slabs or floors can have several finishes (concrete, bituminous materials, etc.). When using bituminous materials, special attention must be paid to the design of the racking.

A slab's thickness and geometrical features must be well-suited to fastening racking footplates to the floor with anchor bolts.

### Handling equipment

Mechanical or electromechanical equipment is not only used to load and unload goods from the racks, but also for transporting these goods from place to place.

The most commonly used types are:

- **Stackers** where the driver sits on board or uses foot-operated models.
- **Counterbalanced forklifts** with three or four wheels.
- **Reach trucks** with a counterbalanced retracting mast.
- **Extended forklift**. Divided into turret trucks, side loaders and order-pickers.
- **Multi-directional forklifts** or four-wheel steered trucks.
- **Stacker cranes** for automatic installations.



Stacker



Counterbalanced forklift



Reach truck



Turret truck



Side loader

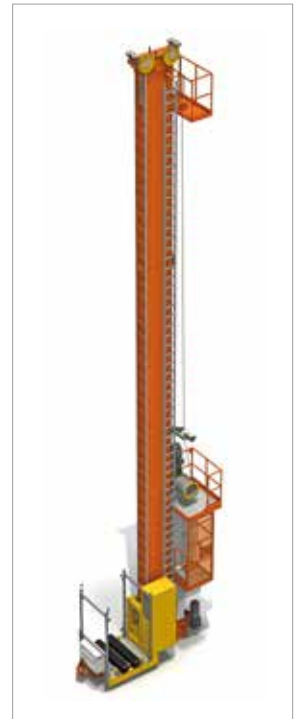

Stacker crane

Choosing these tools is the key to properly handling a palletised warehouse. To do so, the following information must be closely considered:

- sizes,
- manoeuvring aisle needed,
- maximum lifting height,
- maximum load lifting capacity.

A warehouse's capacity depends in great measure on these factors, especially the manoeuvring aisle and lifting height.

The machine must have a load capacity that is perfectly suited to the unit load.

The fork size or storage implements and accessories must be suited to the unit load.

## Storage systems

Below, it explains the procedures used to classify the parts of a storage system.

A storage system is a set of metal racks designed to store unit loads in a safe, organised manner.

**According to the EN 15620 standard**, and the handling equipment in use, storage systems can be classified as follows:

- **Class 100:** pallet racks with narrow aisles operated by automatically controlled stacker cranes.
- **Class 200:** pallet racks with narrow aisles operated by automatically controlled stacker cranes with additional positioning.
- **Class 300:** pallet racks with narrow aisles operated by forklifts, which do not turn in the aisle to load or unload unit loads from the racks. Forklifts are driven the length of the aisle along mechanical guide rails or induction cables.
  - Class 300A:** the operator goes up and down with the load and uses manual height positioning. When the operator remains at ground level, there is a closed-circuit camera system or the equivalent.
  - Class 300B:** the operator stays at ground level and does not have indirect viewing systems.
- **Class 400: Wide aisles:** pallet racks with aisles wide enough so the forklift can turn 90° when loading and unloading the racks.
  - Narrow aisles:** pallet racks with a narrow aisle that can be used by specialised forklifts. .

This safety manual only deals with live pallet racks and the Push-back system.

Its design is determined from data or specifications provided by the user or representative. In particular, the characteristics to be considered for live pallet rack systems or push-back systems are established in the EN 15629 standard (Steel static storage systems - Specifications of storage equipment). Nevertheless, the primary data for any storage system are:

- Units loads,
- Location of the installation,
- Handling equipment used,
- Premises or space being occupied,
- Characteristics of the slab or floor,
- Intended use of the warehouse.

By defining these characteristics, Mecalux can design the best storage system for each customer, always keeping their instructions in mind. All these specifications will be shown in the quote's technical documents and the safe load sign placed at the storage system's entrance.

### Please note!

Any change, modification or expansion of the installation must be analysed and authorised by the Mecalux Group.

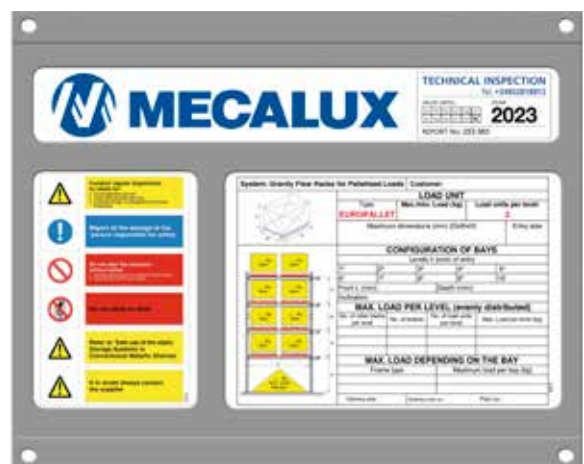

## Live pallet racks

In live pallet racking, the load levels are formed by slightly inclined rollers, which allow the pallets to slide forward. The pallets enter from the highest part of the rack and slide via gravity at a controlled speed until they reach the opposite end. They accumulate one behind the other, being readily available to the user. When the first stored pallet is removed, the one behind it takes its place.

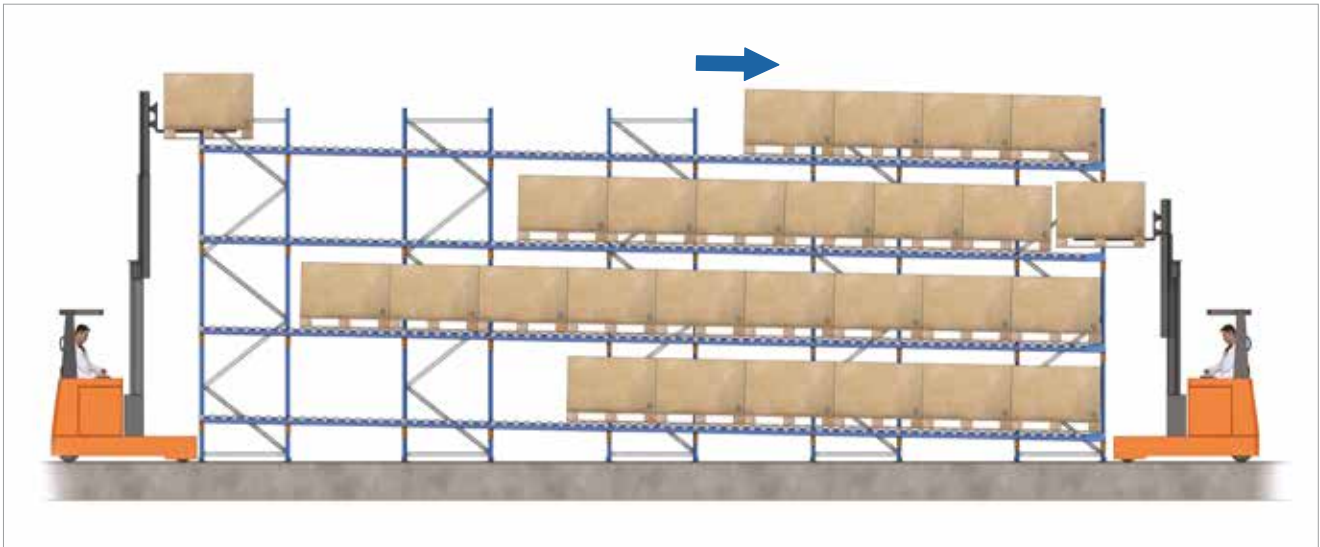

1. Frame
2. Beams
3. Live profile
4. Levelling shim
5. Anchor bolts
6. Rollers
7. Brake roller / Brake drum
8. Pallet centring device
9. Pallet retainer / spacer (optional)
10. Exit beam
11. Exit bumper

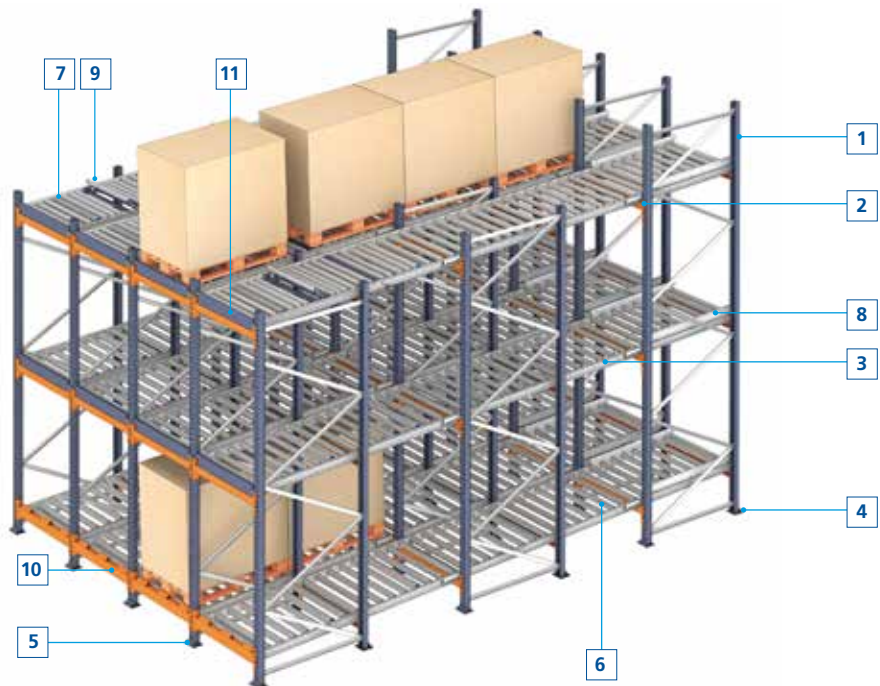

Your installation may only include some of the above mentioned components.  
The constructive system of your warehouse is listed in the layout and technical documents of your quote.



## Description

The basic components of a live pallet rack installation are:

- **Frames:** vertical metal components to support the different load levels.
- **Beams:** horizontal metal components fastened to the uprights, which indirectly support the unit loads on each level and on which the roller track are lain.
- **Rollers:** the characteristics of this component ensure pallets slide smoothly over them. They have flattened edges, which fit into the grooves of the track. The separation between the rollers and their diameters depend on the pallets' type and weight.
- **Roller tracks:** horizontal metal components composed of lateral sections with perpendicular rollers. On each level, they are installed perpendicularly to the operating aisles and the unit loads slide down the tracks at a speed, controlled by the brake drums or the braking rollers.
- **Braking rollers:** these control the speed at which the pallets move over the roller tracks.

Other optional components:

- **Pallet centring devices:** these centre the pallets at the channel entrance.
- **Exit beam or exit stop:** these stop and hold the pallets at the exit. They line up with the lower pallet skids. The exit stop replaces the exit beam when the channel protrudes from the support beam's position.
- **Pallet retainers:** these retain or separate the pallets, making it easier to extract the first one by distributing the pressure exerted between them. They include a set of parts which continue retaining the pallets when the first one is being removed or just slightly raised.

The installation of these items is optional and they depend on the characteristics of the installation and the type of forklifts or storage machinery being used.

The pressure the first pallet exerts on the pedal activates the tabs that retain the second pallet (Figure 1).

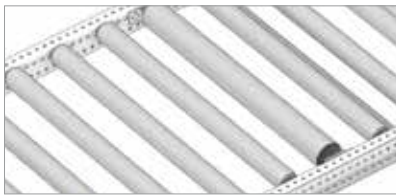

Rollers



Brake rollers



Pallet centring device



Exit beam



Exit bumper



Pallet retainer

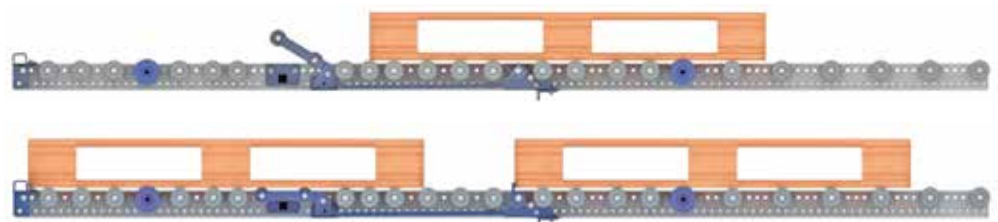

Figure 1. How a pallet retainer works

# Pallet racking for the Push-back system

The push-back racking system is an accumulative storage system that can store up to four pallets per level.

All the pallets on each level, except the last one, are placed on top of a set of carriages which slide over roller tracks when pushed. These tracks are mounted on a slight front-down inclination, allowing the back pallets to move forward when the aisle-side pallet is removed.

The pallets placed on each level must be the same SKU and are handled according to LIFO procedures (last one in, first one out).

## Push-back system with trolleys

These racks function as follows:

- Each load level has two or three parallel carriages set at different heights.
- The forklift **deposits the first pallet** on the highest set of parallel carriages.
- With the second pallet ready for storage, the **forklift pushes the first pallet** until it pushes out the second set of carriages and places the pallet on top of them.
- If the installation has been outfitted to store four pallets, **the operation is repeated for the third pallet**, with the last one resting directly on the roller track, not the carriages.
- To **remove the pallets, the operation is done in reverse**. So, when the first pallet is removed, the rest slide towards the front of the aisle into position.

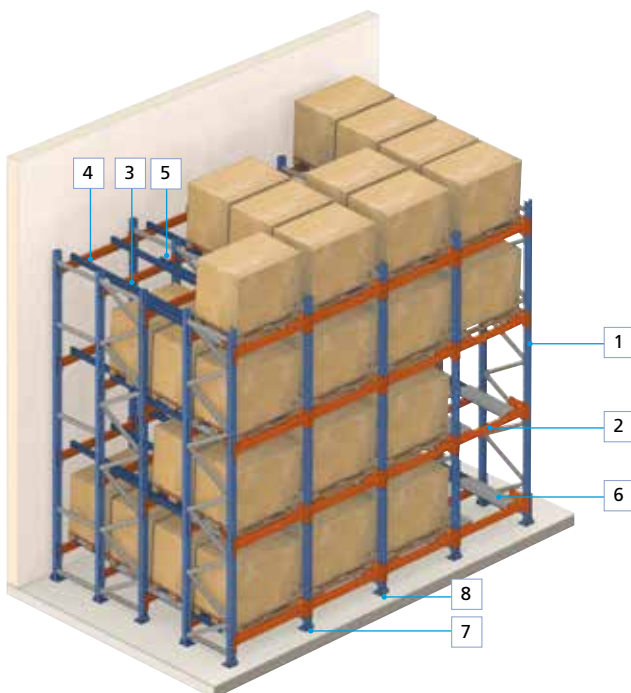

1. Frame
2. PB front crossbeam
3. PB middle crossbeam
4. PB end crossbeam
5. Track
6. PB carriage
7. Levelling shims
8. Anchor bolts

## Description

The basic components of a push-back installation are:

- **Frames:** vertical metal components to support the different load levels.
- **Beams:** horizontal metal components where the load is deposited.
- **Tracks:** the roller track and the carriage are supported on the rack's crossbeams. They are mounted at an appropriate angle, so the carriages can slide forward correctly.



Track (5) and PB track support (10)

The levels are built to store one or two storage channels.

The I-shape of the track allows the rolling components to be housed on both sides of the core, thus ensuring proper sliding and preventing any possible derailment.



PB carriage (6) and PB safety (8).

Pallet centring device (11)

Carriage gauge (9)

- **PB carriages / PB safeties:** each carriage, in addition to its rolling components, has a safety catch that keeps it from sliding if the pallet has not been properly set down.

The front beams have supports and fasteners, in addition to bumpers and drill holes, which allow a gauge to stick out to indicate the presence of an available carriage, primarily needed on higher levels.



### Push-back system with rollers

Another variant of the trolley system is the roller channel system. It operates like the trolley version, with the trolleys and rails being replaced by rollers.

Its construction is the same as the live pallet system. The difference is that pallets are inserted and removed from the same side. Thus, it follows the LIFO system (the last pallet in is the first one out).

With this system, the pallets must be handled from the narrow side to allow their lower skids to rest perpendicularly on the rollers and facilitate their movement.

The pallet loading and unloading process is as follows:



**Step 1.** The forklift places the first pallet on the lower end of the live rack. Normally, this is the installation's only access aisle.

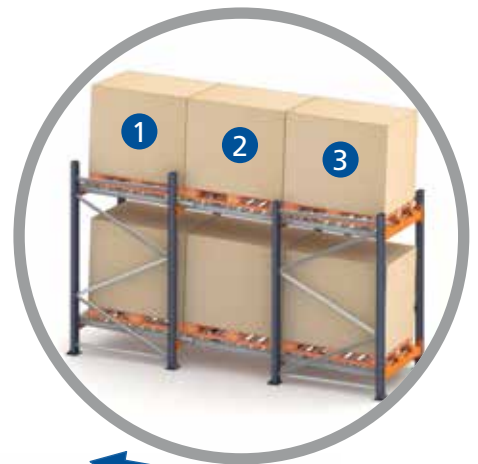

**Step 2.** With the second pallet, the forklift pushes the first pallet into the lane until there's enough room to deposit the pallet. This process is repeated to fill the entire lane.



**Step 3.** Pallets are removed by reversing the process. So, when the first pallet is removed by the forklift, the second moves towards the aisle until it occupies the open location.

## Using your racks and handling equipment

### Unit loads

Unit loads, formed by a pallet or a container, plus the merchandise inside it, must adhere to the following requirements:

- Adjust to the size considered in the racking design, meaning it must not surpass either the maximum defined weight or size (width, depth and height).
- The pallet or container must correspond to the established design and not show any type of damage or wear.

Non-conforming unit loads are those which are damaged or show wear, as defined in the section called "Inspecting unit loads" in this safety manual. A control system must be established to prevent the recirculation of damaged pallets in the warehouse.

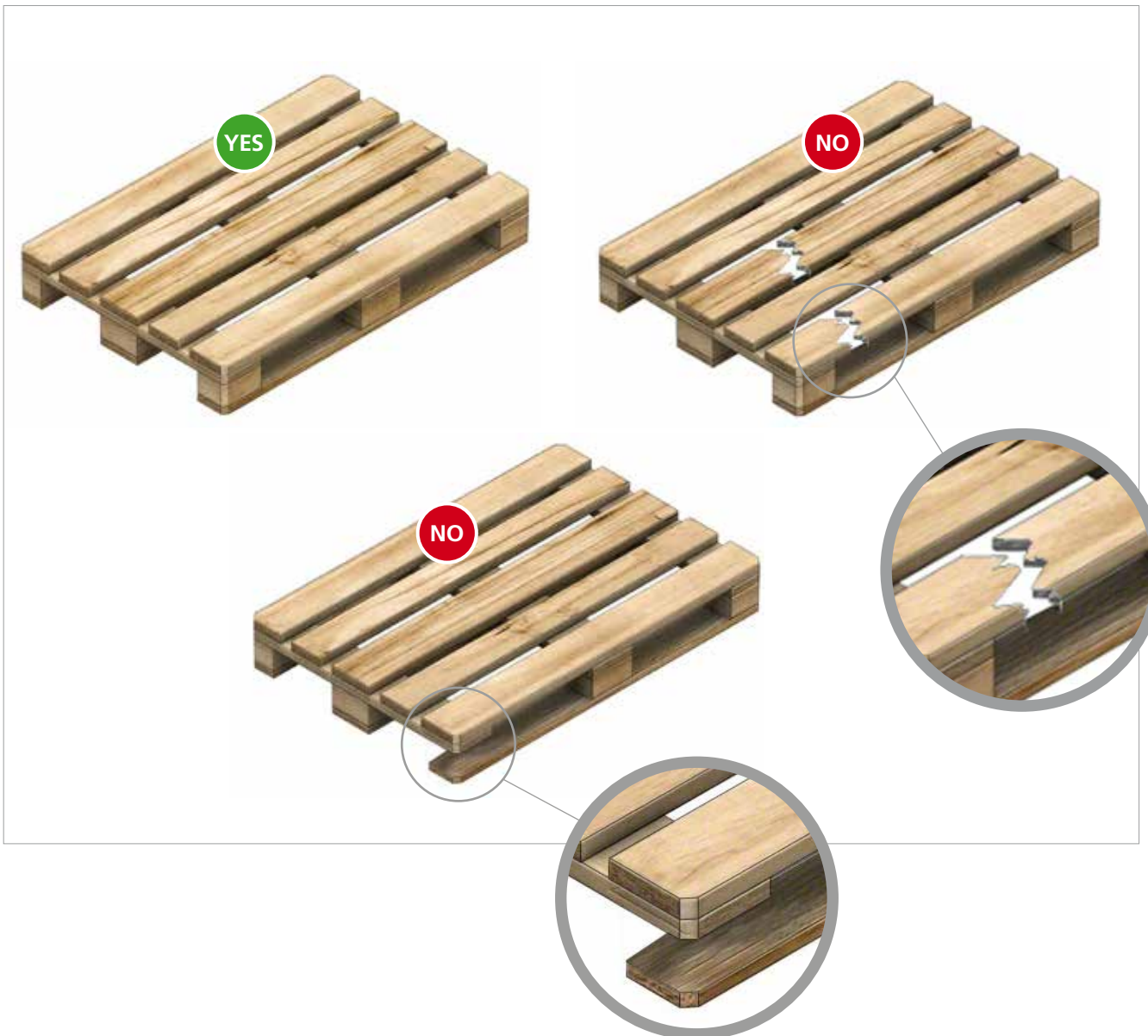

## Using your racks and handling equipment

- The entire unit load must be stable and compact due to its proper distribution, with the goods fastened or tied down using straps, shrink-wrapping, etc.
- Goods must be uniformly distributed on the pallet.

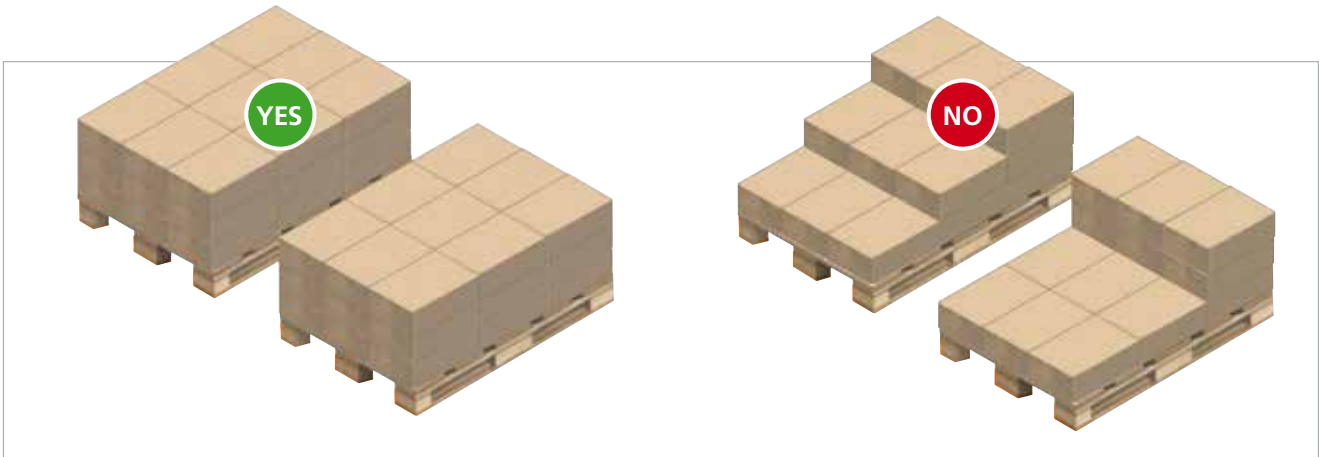

- Goods must be correctly stacked on the pallet.



Standardised pallets adhere to the stipulations in the corresponding regulations:

- **EN 13382**  
Flat pallets for materials handling. Principal dimensions.
- **EN 13698-1**  
Pallet production specification. Construction specification for 800 mm x 1,200 mm flat wooden pallets. (part 1)
- **EN 13698-2**  
Pallet production specification. Construction specification for 1,000 mm x 1,200 mm flat wooden pallets. (part 2)

### Please note!

It is essential that all pallets are in good condition and adhere to the quality standards described in regulations, to ensure the two storage solutions described in this manual work properly.

## Forklifts

### Driving safety

- The forklift operator must be specially trained.
- The forklift must be suited to the load and area where it is being operated.
- Extreme prudence must be taken when turning.
- Avoid turning on ramps or slopes.
- Do not use the forklift as a means of transporting personnel.
- Maintain a minimum distance between forklifts, equivalent to three forklifts.
- Always respect the specific handling regulations for each company.
- Pay close attention to where and how the forklift is parked, when not in use.
- Always face the direction the forklift is moving.
- While driving, avoid excessive velocity, sharp movements and improperly placed loads.

### Load requirements

- Loads with or without pallets must adhere to the minimum requirements that make it:
  - Capable of being handled by forks or the proper tools.
  - Stable enough to keep together during all handling and transport operations.
  - Resistant to the physical demands handling requires.
- Able to be transported 15 and 20 cm off the floor.
- If the volume of the load impedes driver visibility, the forklift must be operated in reverse gear.
- Pay special attention while transporting and depositing cylindrical loads, such as pipes or logs, as they can roll off the forklift.
- Do not take unnecessary risks when the weight distribution of a particular load is unknown.
- Act prudently.
- Do not cover the onboard safety cabin. This will cause a loss of visibility.



### Load – forklift interaction

The forklift is similar to a balanced scale. However, it is possible to lose balance longitudinally by overloading it, situating the load incorrectly, or positioning it at the wrong height.

**Consequences** include tipping forwards, a loss of steering, damage to the load being handled, etc.

Transversal balance can be lost when carrying an off-centre load, turning at an excessive velocity or turning while the load is positioned at an improper height.

**Consequences** include tipping the forklift over on its side (a serious or fatal accident), damage to the load being handled, etc.

### Moving a load

The entire load's centre of gravity must be kept as low as possible, which is why loads are carried on the lowest fork level, around 15-20 cm off the floor, thus giving plenty of visibility by limiting the size and height of the load. The maximum height of the load must be less than the height of the fork carriage. If loads must be carried higher than the mast, first check whether it should be joined or tied to the rest of the load. Transporting loads is always done using both forks, with the load always distributed evenly to ensure stability.

Never travel or leave the forklift parked with the forks raised (figure 1).

Always face the direction the forklift is moving.

Loads must be carried while fastened accordingly with bands, straps, shrink-wrapping, brackets, etc. Any loose material must go into containers.

In cases where visibility is difficult due to the load's volume, use the reverse gear to transport it (figure 2).

On slopes or ramps, drive forward going up and reverse going down, so the mast is always inclined backward in a straight line (figure 3).



Figure 1. Do not transport with the load in a raised position.



Figure 2. How to move bulky loads.

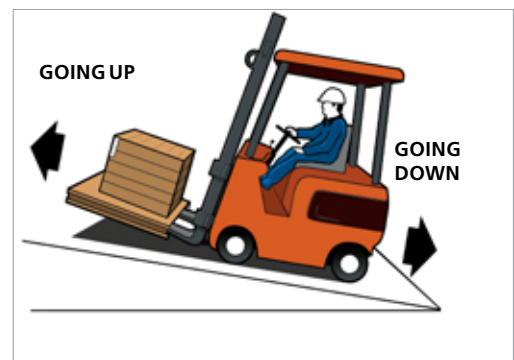

Figure 3. How to drive on slopes.

If there is a lack of visibility due to meteorological or environmental conditions, such as darkness, use all available lights.

Use the horn to warn nearby personnel of your position at intersections with blind spots, always facing the direction the forklift is moving. Pedestrians have the right of way at intersections and traffic lanes where both forklifts and pedestrians may be travelling. If a forklift is carrying out certain manoeuvres (loading, unloading, lifting, etc.) in these traffic areas, pedestrians must wait until they have finished their tasks before continuing on their way (figure 4).



Figure 4. Slow down at intersections.



Pay special attention when driving in reverse in narrow areas with stationary objects. Avoid driving excessively fast and making sudden movements (figure 5).

When two forklifts are travelling in the same direction, a minimum distance equivalent to three forklifts, including their loads, must be kept between them (figure 6).



Figure 5. Pay attention to the installation's size limits.

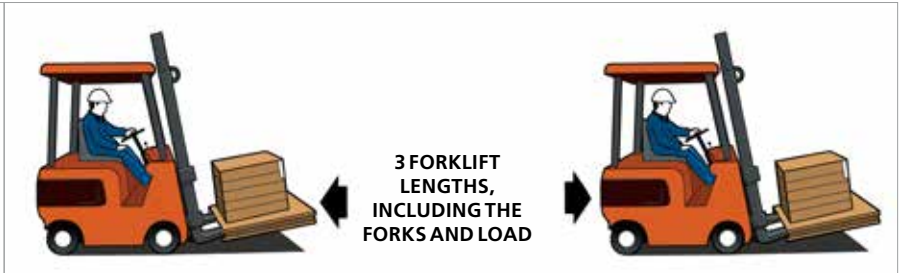

Figure 6. Keep a proper distance between two forklifts.



Figure 7. Work centre speed limit.

Respect all rules and traffic signs. The maximum speed limit inside a work centre is 10 km/h (6 mph), which is a brisk walking speed (figure 7).

Ramps used to cover small differences in floor heights must be fastened to the floor to keep them from sliding.

The operator's entire body must always be kept inside the vehicle (the safety cabin). At no time may drivers operate the vehicle with their legs or arms hanging outside.

Verify the quality and strength of the floor being travelled on and check whether it can support the weight of the forklift and the load.

If the forklift drips oil, its motor overheats, or brakes slip, etc., it must be parked in an area which does not interfere with personnel, equipment or the work in progress. These circumstances must be reported to the immediate superior.

If an emergency occurs and the forklift goes out of control while transporting loads or carrying out operations (figure 8):

- Do not jump out.
- Hold the steering wheel firmly.
- Press your feet firmly to the floor.
- Lean in the opposite direction to the impact.



Figure 8. Losing control of the forklift.

### Loading/unloading operations

The structure of conventional pallet racks is calculated to work under normal service conditions (static loads). These conditions are not fulfilled if forklift operations cause collisions, use pull/push movements, place loads suddenly, etc.

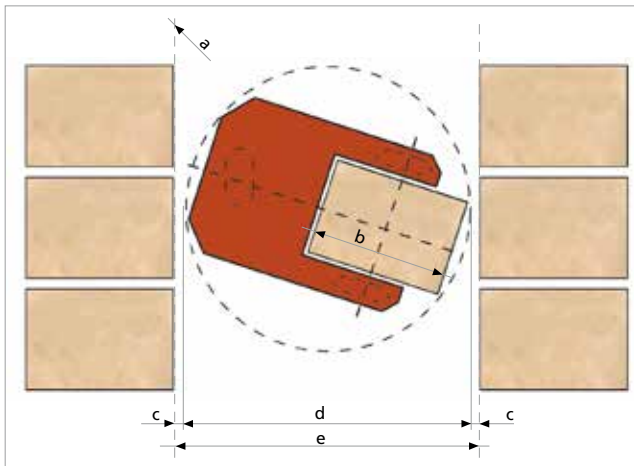

- a. Maximum line of pallet exits.
- b. Maximum dimensions of pallet and load.
- c. Clearance.
- d. Forklift and load turning diameter.
- e. Open aisle area between loaded pallets.

Therefore, besides properly training staff in the use of forklifts (i.e. accident prevention), the following aspects must be specifically considered:

- the **aisle between loads** (e) must allow for a forklift and its load to turn properly without it colliding with the racks (d), due to the necessary clearance (c);
- the **speed used while moving**, loading and removing the load from the rack must be appropriate and suited to the features of the unit load;
- the **forklift** must move vertically toward the gap and be positioned frontally, with the load raised slightly off the floor.

## Live pallet racks

Live pallet racks are exclusively designed to insert pallets at the rear (the highest part) and extract them from their front (the lowest part).

When using a live pallet storage system, bear these factors in mind:

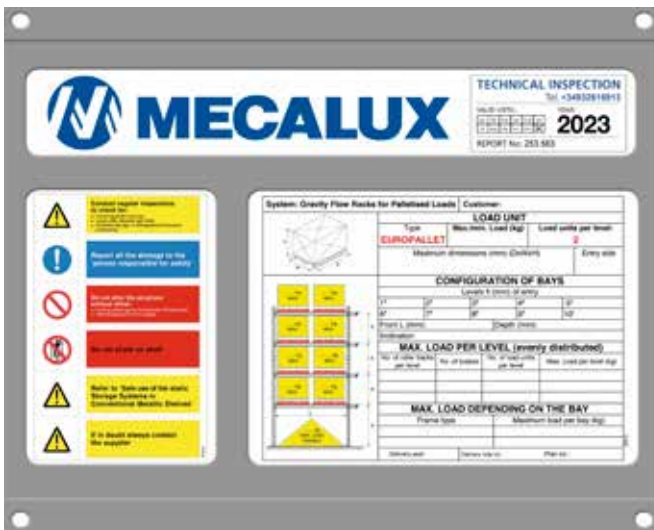

### Factor 1. Established design

The established design must not be changed in any shape or form (unit loads, geometry, etc.) without consulting the Mecalux technical departments.

It is expressly prohibited to:

- Modify the height of the levels,
- Modify the number of levels (even when maintaining the load per frame),
- Modify the profiles,
- Remove or add levels,
- Use the installation in a way that damages its primary components (frames, beams, locking systems, braces, etc.)
- Use the installation without all its components (frames, beams, locking systems, braces, etc.),
- Use the installation when a frame is out of alignment.

## Please note!

The installation's characteristics are described in the technical information of the Mecalux quote and on the safe load sign placed at the entrance of the storage system.

### Factor 2. Placing unit loads

In a live pallet system, pallets must be handled so the bottom skids are supported perpendicularly over the rollers, which allows the load to slide.

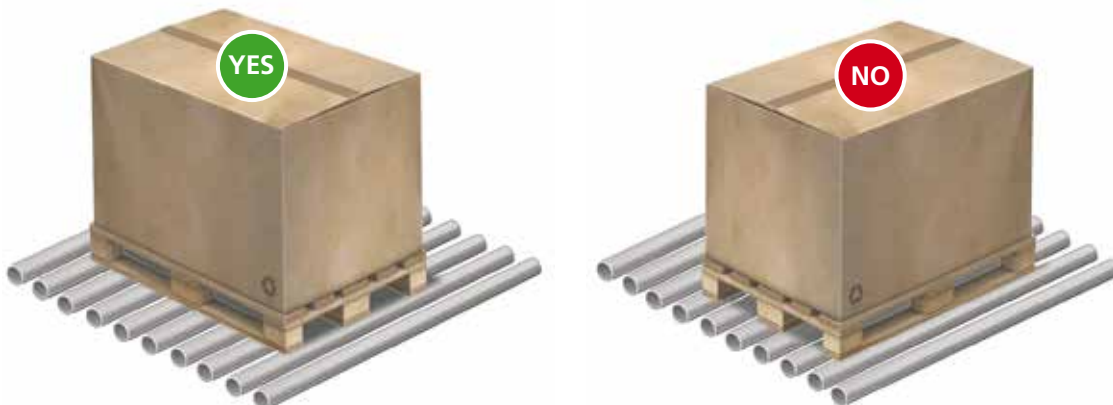

**Factor 3. Clearance margins**

The clearances allowed in a live pallet racking installation depend on the size of the pallets, the depth of the facility, the lifting machines used, etc.

The most common tolerances are shown in this section.

Frontal clearances (in mm)						
A	B	C	D	E*	F	H**
800	80	15	830	960	283	350
1.000	80	15	1.030	1.160	283	350
1.200	80	15	1.230	1.360	283	350

\* If the load bulges over the sides, the lane width (E) increases.

\*\* (H) min. 350 mm. Dimensions in mm.

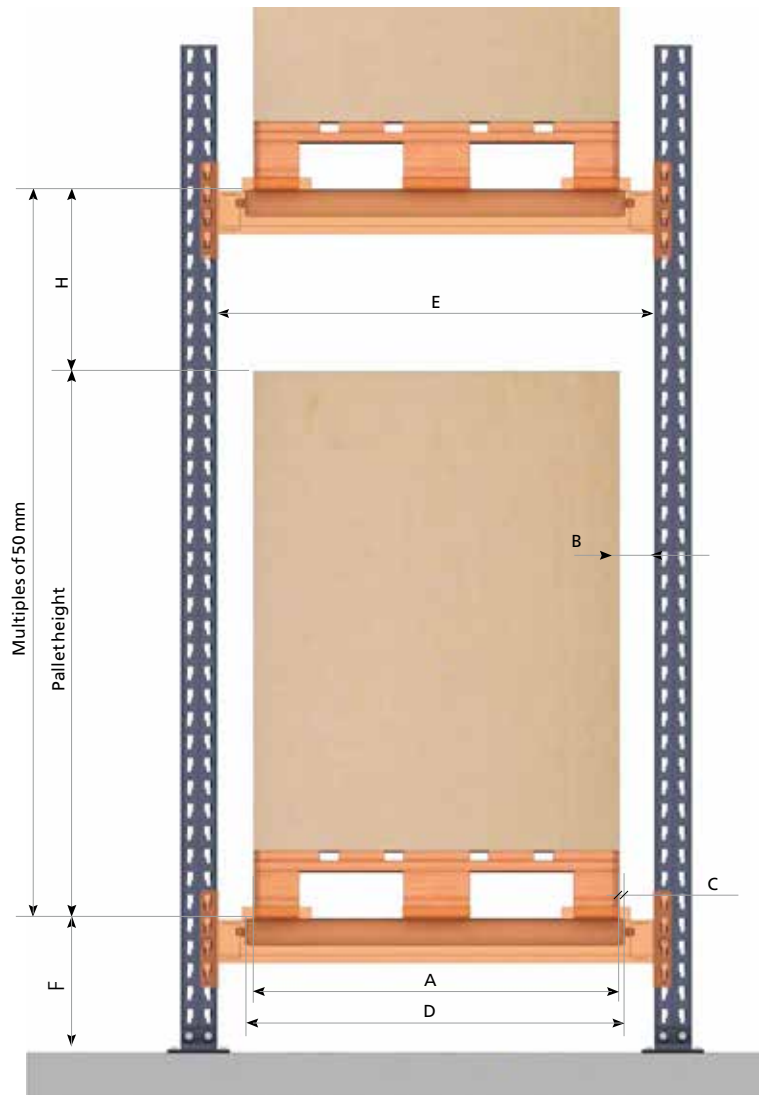

**Factor 4. Loading methods**

The pallets must be centred when loaded. So, the middle of the pallets must be in good condition and blows avoided to them.

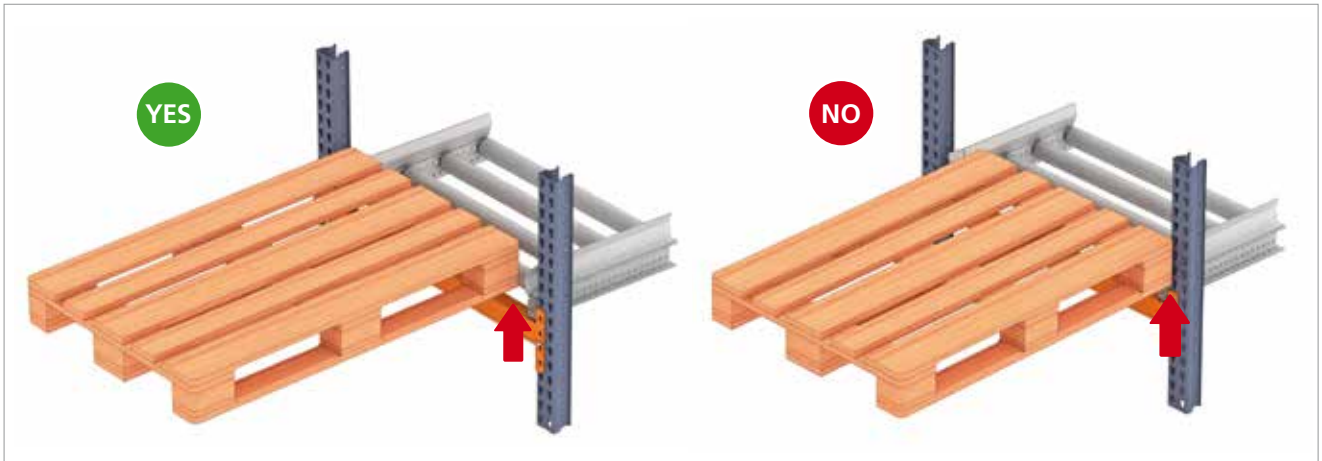

The load must be raised during insertion to prevent it hitting the roller guard.

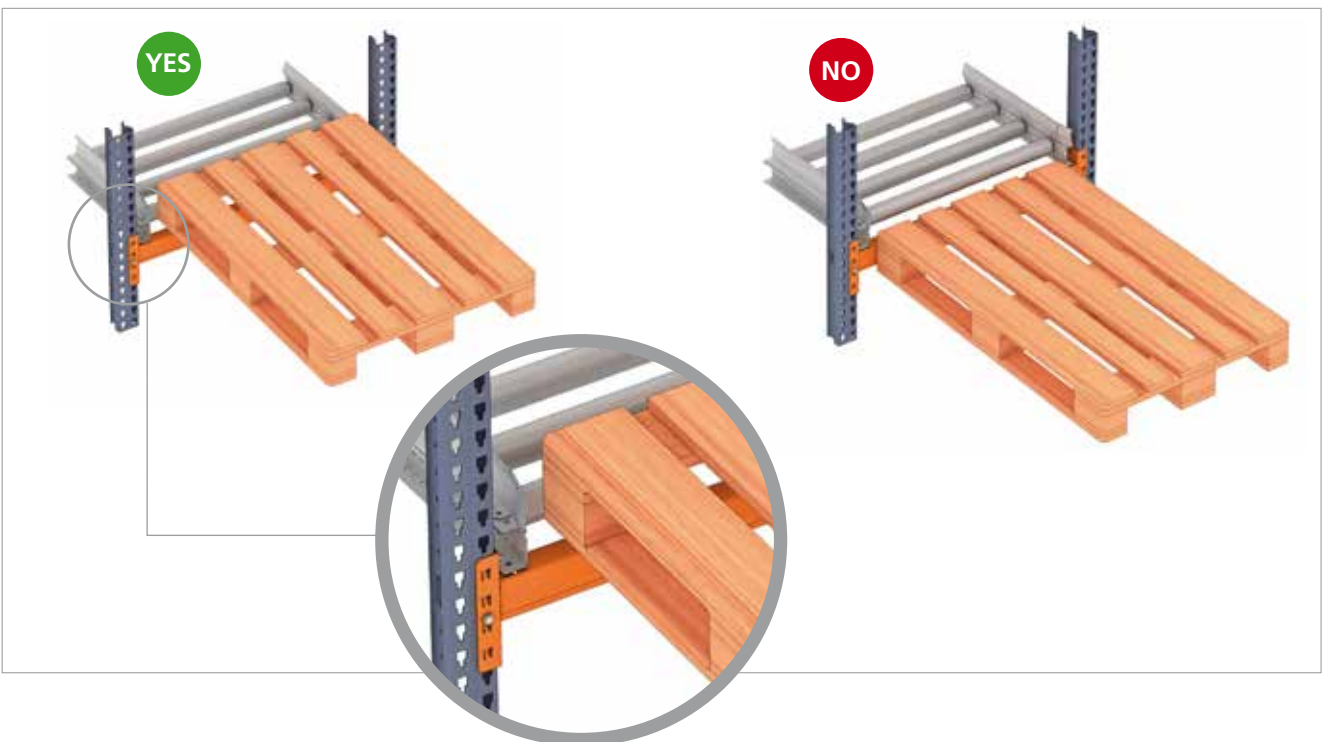

The load must be raised and lowered with the forks centred and in a horizontal position. The operation must take place at the lowest possible speed.

The unit load must never be dragged into the centre position. Instead, lower it into place.

The frames and crossbeams, which limit the space where manoeuvring is done, must always be visible, as well as the unit loads adjacent to the load being handled.

## Using your racks and handling equipment

Avoid hitting the rollers. A damaged roller can turn or stop pallets.

When removing pallets, they must be properly centred on the forks and avoid hitting the exit beams or bumpers.

For installations which use pallet retainers, particularly between the 1st and 2nd pallet, bear in mind that:

- When removing the first pallet, it must not be lifted more than 50 mm to prevent the retainer from unlocking before completely removing the pallet.

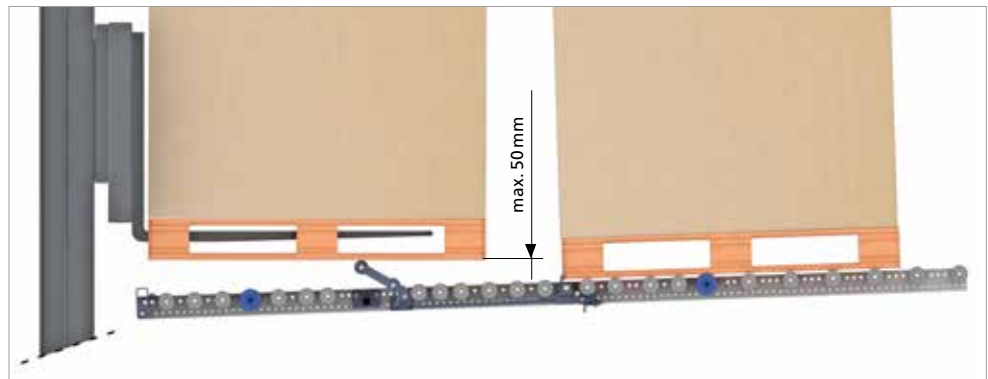

- Never insert pallets into the exit point.



- Each retainer is valid for only one type of pallet, as indicated on the technical specifications of the safe load sign. If different pallets are inserted, the retainer will not operate properly and accidents may occur.



### Please note!

Once the pallet has been taken off the roller exit lane, it cannot be put back using this same lane.  
Once the pallet has been lifted off the rollers, it must be lifted off completely and cannot be placed back into the same position.

## Pallet racks for a Push-back system

When using a push-back storage system, bear these factors in mind:

### Factor 1. Established design

The established design must not be changed in any shape or form (unit loads, geometry, etc.) without consulting the Mecalux technical departments.

It is expressly prohibited to:

- Modify the height of the levels,
- Modify the number of levels (even when maintaining the load per frame),
- Modify the profiles,
- Remove or add levels,
- Use the installation in a way that damages its primary components (frames, beams, safety pins, braces, etc.)
- Use the installation without all its components (frames, beams, safety pins, braces, etc.),
- Use the installation when a frame is out of alignment.

### Please note!

The installation's characteristics are described in the technical information of the Mecalux quote and on the safe load sign placed at the entrance of the storage system.

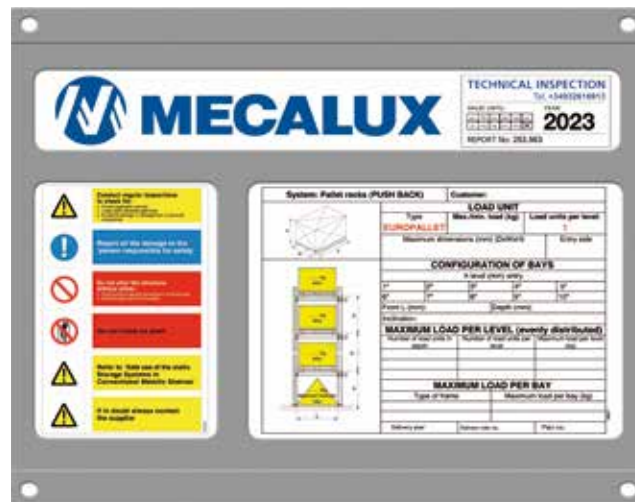

**Factor 2. Placing unit loads**

Pallets must always be placed with their bottom skids transversal to the carriages and tracks of the different levels, and also be in good condition.

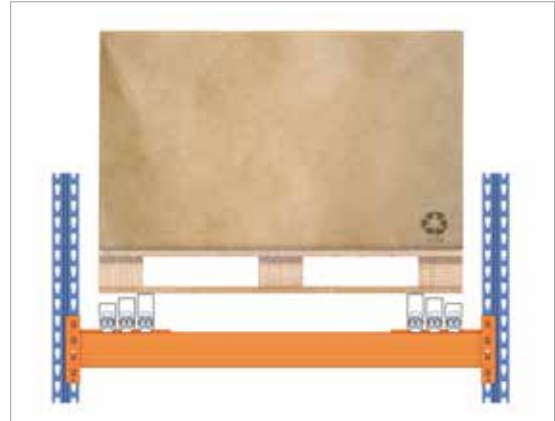

The pallet must always be properly centred.

The pallet must only rest on the two corresponding carriages.

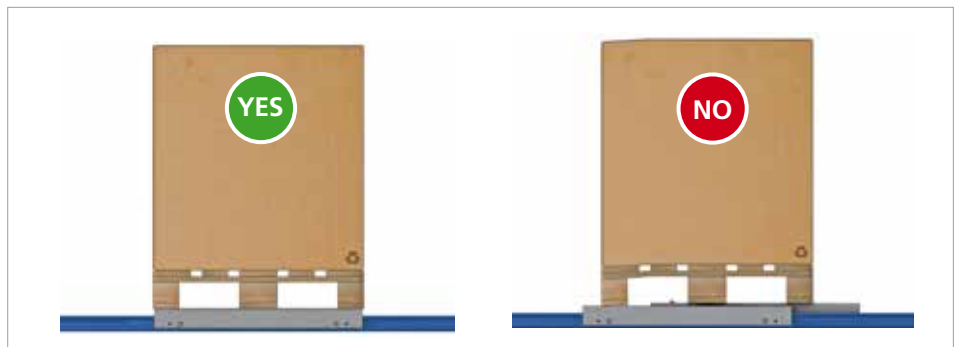

**Factor 3. Clearance margins**

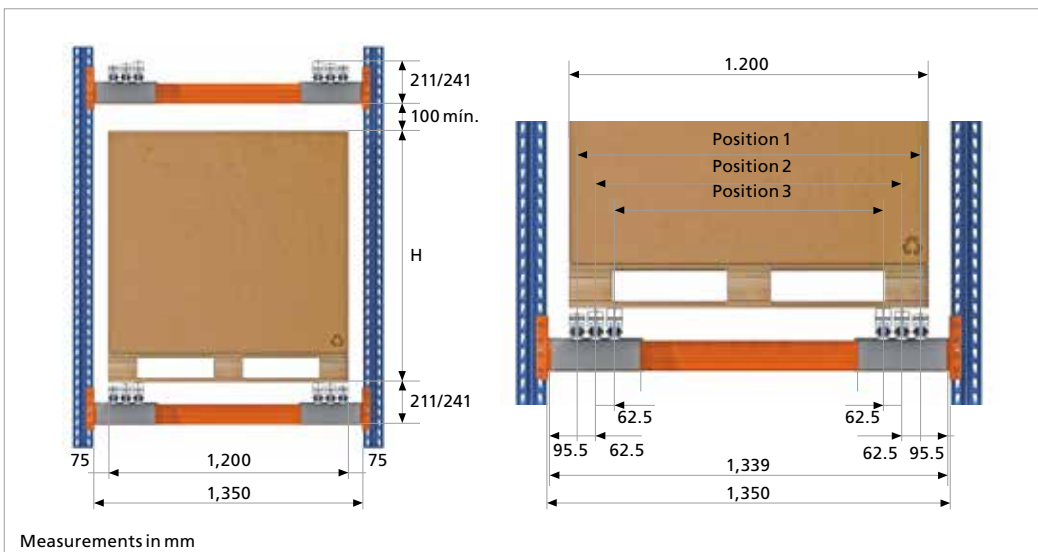



**Factor 4. Loading methods**

The last pallet to enter always rests on the track itself, as each level has one less set of carriages than the number of pallets that can be stored on the level.

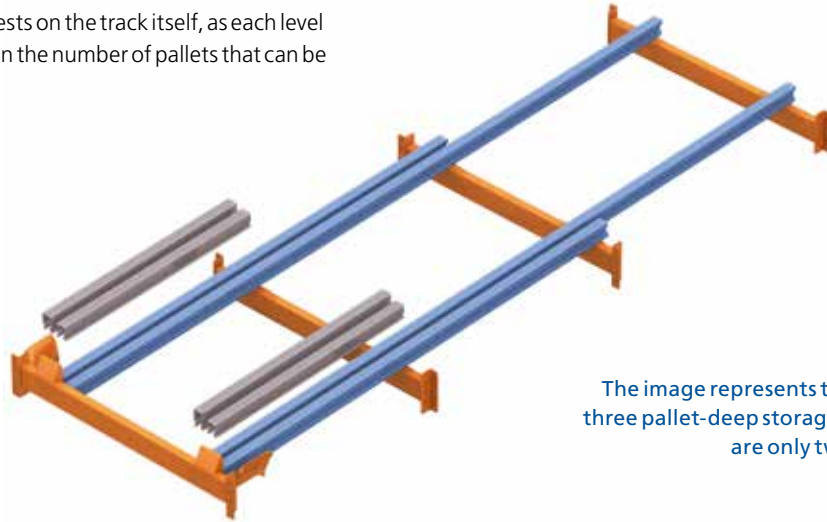

The image represents the composition of a three pallet-deep storage level. Notice there are only two sets of carriages.



**Four-pallet system**

This system has six tracks with three different measurements and six carriages. The first, second and third pallets are stored on the carriages and the fourth directly on the tracks.



---

# Inspection and maintenance

## Inspecting your storage system

### According to EN 15635:

There must be a Person Responsible for Storage Equipment Safety (PRSES). Racking bays and the storage system area must be regularly inspected and done so specifically when any damage has occurred to either.

A thorough maintenance program must be carried out in the entire facility, with the recommendation that it be done by or as per the rack's manufacturer. These programs must include the following aspects, among others:

**A.** When establishing a preventive maintenance program, safety checklists should be created that help streamline inspections and ensure any detected irregularities are reported.

**B.** The establishment of a periodic inspection plan to detect, report and record plainly visible irregularities, such as: the order and cleanliness of storage and traffic areas, deformed structural components, vertical defects, floor weaknesses, missing safety locking systems, deteriorated unit loads, etc., so their immediate repair can be carried out.

**C.** If the degree of stock rotation and the number of working hours in the warehouse are both quite high, a specific plan of periodic inspections must be established to report any damages, which as a minimum must include:

- **A daily visual inspection** carried out by warehouse personnel to detect plainly visible irregularities such as: deformed beams and/or frames, floor cracks, missing shims, broken fasteners, missing safety locking systems, worn out unit loads, missing signs and placards, floor or slab damage, etc. and consequently, their immediate repair or replacement.

- **A weekly inspection**, carried out by the warehouse manager or the Person Responsible for Storage Equipment Safety (PRSES), who must verify the verticality of the structure and all the components on the lower levels (1st and 2nd), properly notifying, classifying and reporting any damages.

- **A monthly inspection**, carried out by the warehouse manager or the PRSES, which also includes the verticality of all levels of the entire installation and the general orderliness and cleanliness of the warehouse, properly notifying, classifying and reporting any damages.

- **An annual inspection**, carried out by an expert who is competent and experienced in this activity, who must properly notify, classify and report any damages.

All repairs or modifications which result from the racking status reports must be carried out by qualified personnel from the racking manufacturer or supplier. These tasks must be done with the racks completely unloaded, except if a prior analysis has been performed on the risks of making repairs with them partially or fully loaded.

After a blow, and depending on the resulting damages, any deformed structural component must be repaired or replaced, verifying the verticality of the racking. The new component must be identical to the one being replaced and must never have been heated (soldering), as this alters the mechanical properties of the steel.

All potential causes of any damage must be investigated to reduce or eliminate this problem from arising and to avoid the damage from re-occurring.

Any observation regarding the status of the structures and floor must be written down in a log, stating the date it was observed, the nature of the irregularity detected, any repair work done and the date. It also must include any information related to the loads.

The consequential damage assessment or safety issues must constitute the basis for establishing damage prevention measures.

**Immediate warning**

Any damage caused to the racks diminishes the resistance and safety coefficients considered in their calculation. As such, all damages observed in the installation must be immediately reported by any warehouse employee to the Person Responsible for the Storage Equipment Safety (PRSES).

Consequently, all warehouse personnel will receive formal instructions on how to safely operate the system, thus guaranteeing their own safety and of others.

**Important information about the customer/user responsibility according to EN 15635:**

The customer/user is responsible for the safety of others and for maintaining the equipment (racking, forklifts, etc.) in safe working condition.

Therefore, they are also responsible for ensuring that the previously mentioned inspections are carried out and that the information stated in the regulation is observed; this includes designating a Person Responsible for the Storage Equipment Safety and preparing a risk prevention plan for the installation.

**Precautions during inspections and solving incidents**

The hazards of inspecting or working on live roller lanes used for transportation are the following: risk of falling, risk of slipping, risk of being crushed and risk of injuries from sharp edges.

Safety instructions posted on signs shown in the working areas must be followed at all times.

Before inspecting the equipment, you must make sure that the lane is locked.

When inspecting or resolving an incident, avoid filling the lane.

Carry out tasks wearing the required personal protection equipment (protective gloves, safety boots, helmet).

Live roller lanes on racks must only be accessed through adequate means (forklift with authorised basket/operator lift platform).

In the event the pallets remain loaded in the rack's lanes, the inspector or operator must always be behind the pallet (in the same direction as the rollers move).

Pallets should only be pushed, never pulled. To do so, various auxiliary tools can come in handy, such as metal levers or pry bars.

Any potentially dangerous defects detected in the storage equipment must be repaired immediately. Damaged storage equipment must not be used until fully repaired.

## Maintenance instructions

Once in operation, carry out maintenance tasks at regular intervals, at least every 12 months.

Maintenance must only be carried out by specially qualified personnel.

Live roller units are dynamic, gravity flow systems. This means that all bolted joints must be periodically inspected and repaired, whenever necessary.

Brake rollers keep the travelling speed on the live unit constant. The operating speed of a brake roller must never exceed 0.3 m/s, or else it may suffer damage. Brake rollers must be checked every 12 months and must be readjusted, whenever necessary.

## Inspecting frames

Illustrations A, B and C show a few examples of critical deformations.

A 1-metre long ruler is placed against the upright to properly check for structural deformations, placing its halfway point at the area of greatest deformation, as shown in drawings A and B.

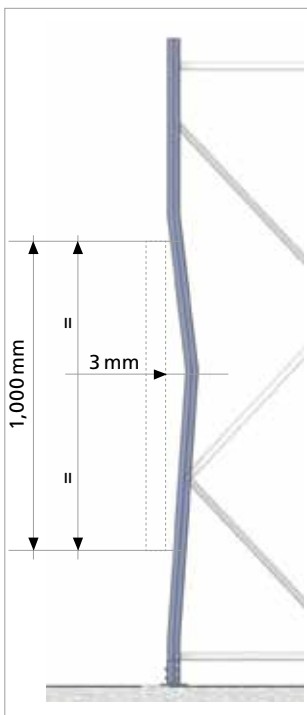

**A.** Uprights bent in the direction of the frame's plane, with a permanent deformation equal to or greater than 3 mm, as measured from the centre of a 1-metre long interval.

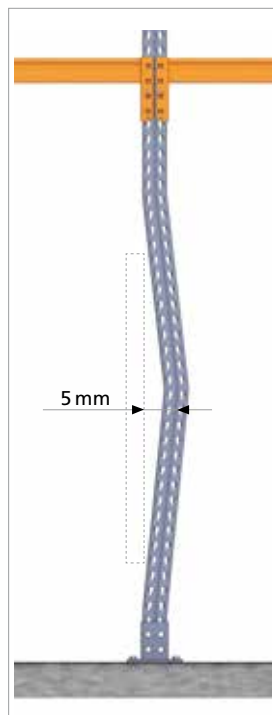

**B.** Uprights bent in the direction of the beam's plane, with a permanent deformation equal to or greater than 5 mm, as measured from the centre of a 1-metre long interval.

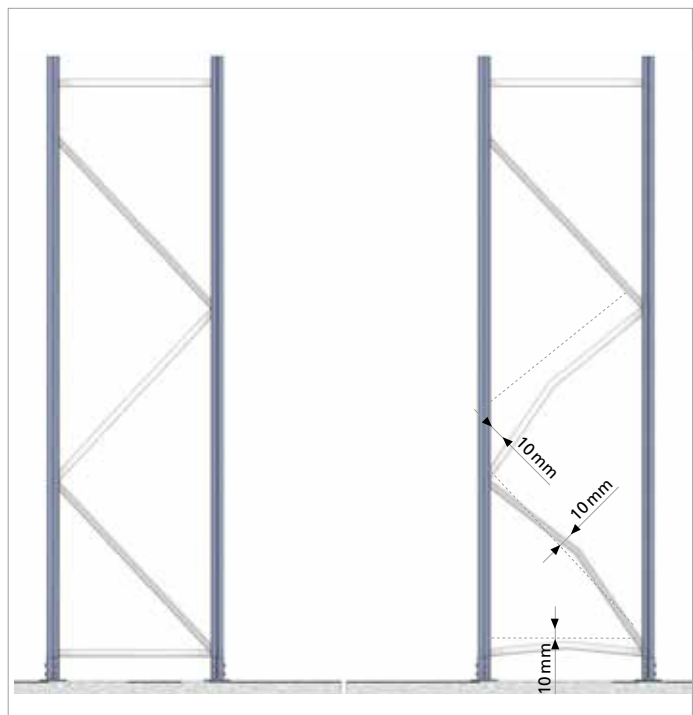

**C.** Permanent deformations equal to or greater than 10 mm in horizontal and diagonal components, in any direction. For lengths less than 1 m, a 10 mm value can be linearly interpolated.

As a rule, profile deformation is classified as green, amber and red.

**Green:** when deformations are no greater than illustrated above. This level only requires vigilance, and the installation need not lower its storage capacity.

**Amber:** when the deformations are greater than the previous illustration but do not surpass twice its value.

**Red:** a red risk level is when the deformations are more than twice of those specified in the previous illustrations, or if there are creases, shearing or dents. The frame is considered unusable whatever the measured deflection may be, and thus classified as the highest damage level.

In any case, even when the indicated limits have not been reached, bear in mind that the frame's load capacity has been severely reduced. In case of doubt, remove the frame from service (unload).



Gouged upright



Dented upright

### Inspecting racking bays

The European EN 15635 standard must be taken into account, as well as the UNE 58013 in Spain.

The following flow chart outlines the procedures to follow if a rack has been damaged.

## DAMAGED RACKING

The rack inspector or PRSES must evaluate and classify the damages according to applicable EN standards.

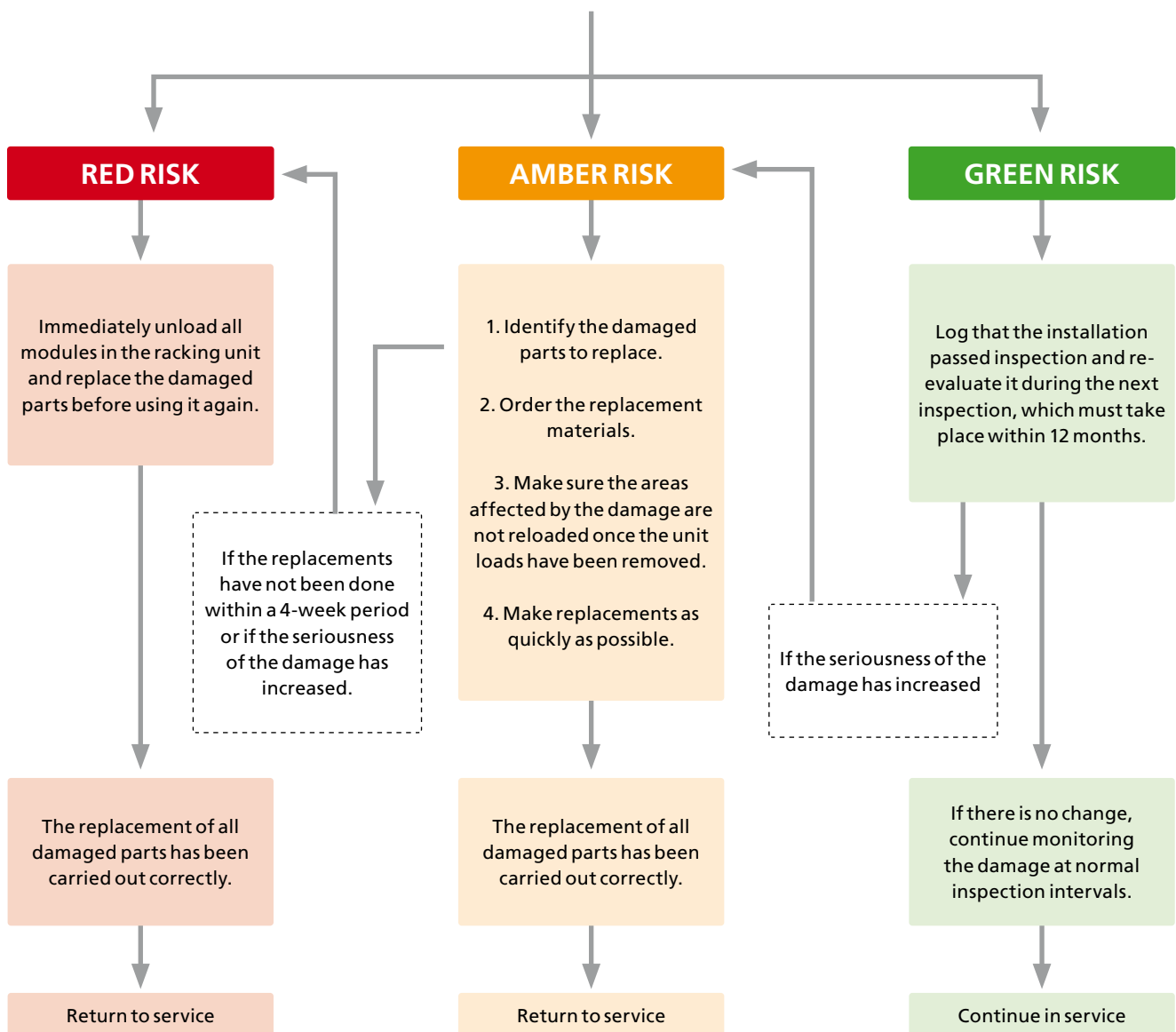

### Inspection procedure for classifying damages

## Inspecting beams

In the following cases, the affected beam must be unloaded and replaced.

- Permanent residual vertical deformation (what remains after unloading the beams) which is greater than 20% of the deformation or nominal deflection ( $L/200$ ) when loaded.



- Residual lateral deformation greater than 50% of the deformation or nominal vertical deflection ( $L/200$ ) when loaded.



- The welds on the safety pins are cracked or have fissures.



- One or more connector tabs are torn off, open or visibly cracked.

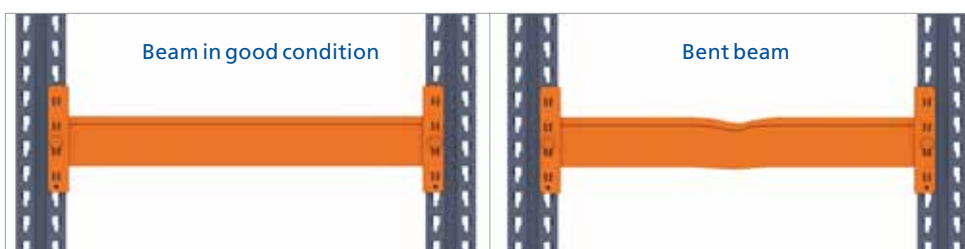

Localised damage in the form of dents, splitting, etc. must be evaluated one at a time. In case of doubt, the level must be unloaded, and the damaged beam changed.

## Locking system

It is essential that all beams include a safety locking system, to thus avoid a beam from accidentally slipping out of place.



**Rollers**

Replacement is necessary in the following circumstances:

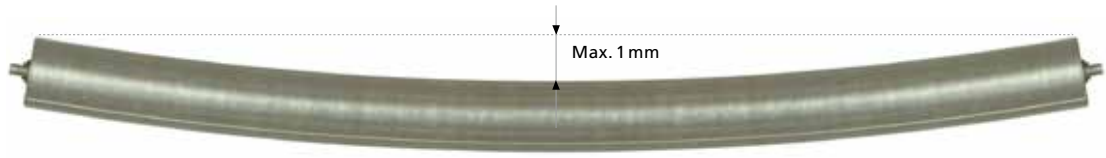

Roller is bent



Roller is dented

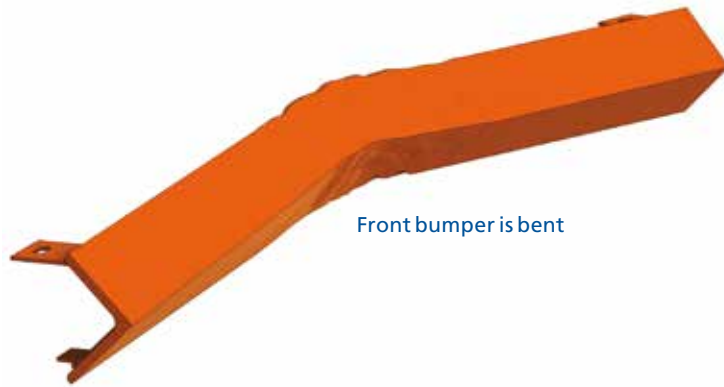

Front bumper is bent

**Carriages**

It is essential that a carriage has no dents and all four wheels are intact. If not, it must be replaced.



The damaged components specified above must be replaced.  
The replacement of components must be done according to the structural analysis carried out by the manufacturer.



## Assembly tolerances

An installation must always be within the assembly tolerances in terms of verticality. This ensures that structural elements function properly.

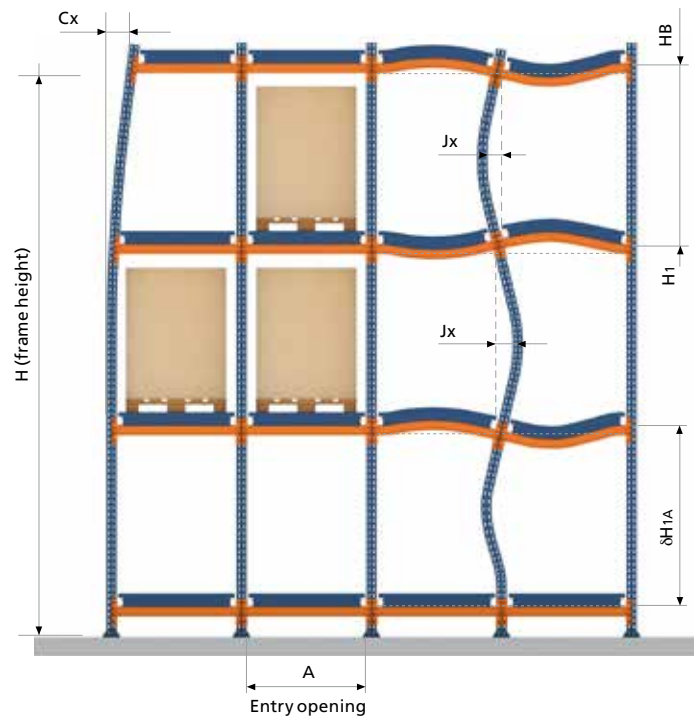

The maximum admissible measurements after assembly must not surpass the following values:

### CLASS 300 A and B

Cx:  $\pm H/500$

Jx:  $\pm 3 \text{ mm} \text{ o } \pm HB/750$

$\delta H_{1A}$ : the variation must be  $\pm 7 \text{ mm}$  in each upright from the floor to the beams' upper part of the lowest level.

### CLASS 400

Cx:  $\pm H/350$

Jx:  $\pm 3 \text{ mm} \text{ o } HB/400$  (the highest of both values)

The difference in height between the top part of the front and the rear crossbeams within the same space:  $H_y \pm 10 \text{ mm}$  (valid for both class 300 and 400 racks).

In addition to the previously mentioned tolerances for 300 and 400 class racks, the stipulations mentioned in the EN 15620 standard must be fulfilled.

## Inspecting floors and aisles

The floor, as a principal component of the installation, must be checked for the following attributes:

**Planimetry:** The floor must respect the horizontal alignment for which the warehouse has been designed. Otherwise, the system's aplomb could be affected with the resulting installation fall hazards. Any irregularities in the floor can be corrected by placing metal shims under the footplates of the storage system. Make sure these levelling shims are placed correctly.

The slab must have the proper resistance to bear the pressure transmitted by the frame footplates.

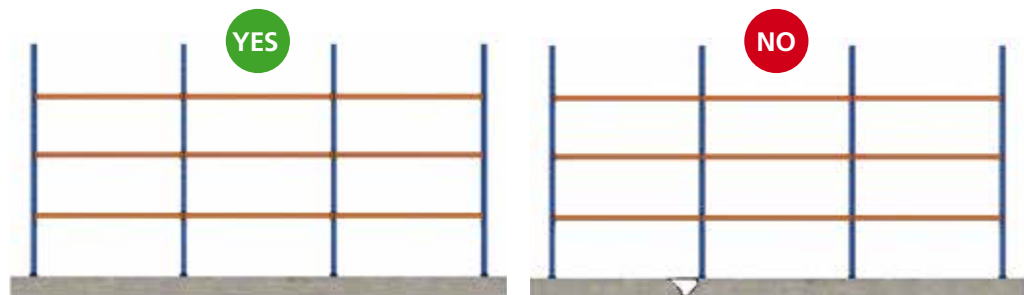

**Resistance:** The floor must not have areas that appear to have sunken, as this may cause the installation to collapse. The floor must have the proper resistance to bear the loads that the storage system transmits onto the footplates.

If areas of the slab begin to sink or shift, the frame verticality may be at risk.

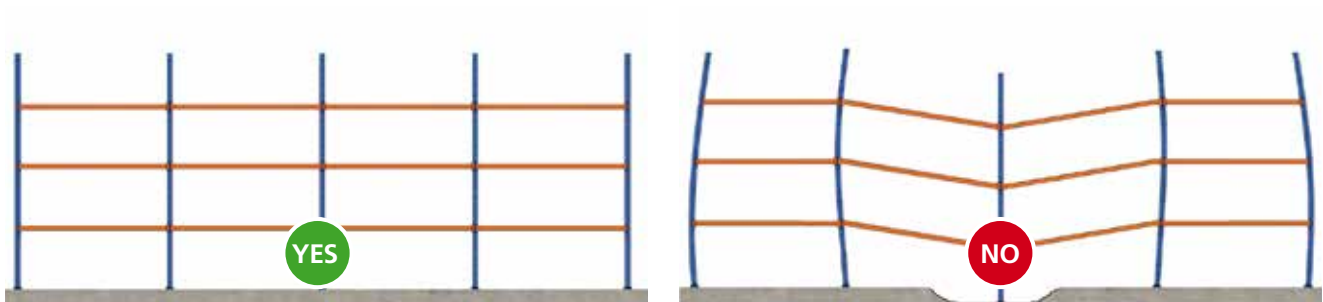

Any irregularities in the floor can be corrected by using levelling shims, which must be perfectly lodged beneath the footplates. Any incorrect positioning of these shims will increase the pressure on the slab and even cause the frame to be out of aplomb.

**Cleanliness:** All passageways, operating aisles and areas with traffic must be kept clean and obstacle-free to create safe operating conditions. In other words:

- Do not put obstacles in the middle of the aisle, to minimise the risk of blows against the storage system.
- Avoid oil spots, spilt liquid or anything else that may cause the handling equipment to lose traction or personnel to slip and fall.

## Inspecting unit loads

Keep a close eye on the pallets to ensure they are in good condition, replacing any which are damaged as stipulated in the EN 15635 standard, annex C.

Moreover, a pallet may no longer be used if:

- Nail heads or ends are sticking out of the slats.
- The wrong parts were used to make it (the slats or spacers are too thin, narrow or short).
- The general condition of the pallet is so poor that it cannot handle its load capacity (e.g. rotten slats, warped or bent slats and/or spacers) or there is a risk of getting the merchandise dirty.

Skid pallets can no longer be used if, in addition to the previous deficiencies:

- Their slats are broken or missing.
- There is wood missing in the guide skids to the point where two or more nails are visible on one slat, or one or more nails are visible on more than two slats.
- The spacers are missing, broken or warped, or set in such a way that a nail is visible.
- Its required labelling is absent or illegible.

The previously mentioned indications are also valid for any type of pallet on the market today.

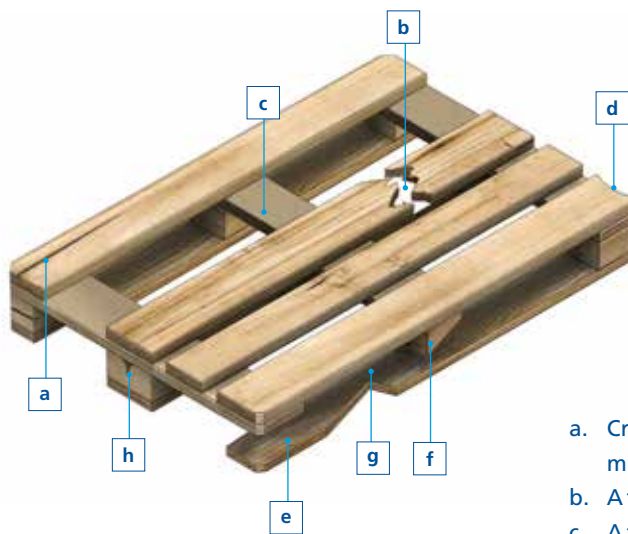

- a. Cracks in any of the top slats along the width or length of its midsection.
- b. A top slat is broken.
- c. A top slat is missing.
- d. Wood is missing on a top slat over more than a third of its width.
- e. A spacer is missing.
- f. A spacer(s) is turned more than 30°
- g. Wood is missing on a top slat between two spacers and in more than ¼ of its width, or when the nails are visible .
- h. Wood is missing or there are cracks in the spacers in the midsections or at the top of the spacer.

Pallets and containers set aside due to wear and tear must be kept apart and under control, using a system that impedes their reuse or return to the warehouse.

Make sure that merchandise located on the pallets is kept in good condition, stabilised and strapped down and/or shrink-wrapped.

Make sure unit loads do not surpass:

- The maximum nominal weight established for the design and use of the warehouse.
- The maximum nominal dimensions established for the design and use of the warehouse.

Standardised pallets must adhere to the stipulations in the corresponding regulations:

- **EN 13382:** Flat pallets for handling merchandise. Principal dimensions.
- **EN 13698-1:** Pallet production specification. Construction specification for 800 mm x 1,200 mm flat wooden pallets. (part 1)
- **EN 13698-2:** Pallet production specification. Construction specification for 1,000 mm x 1,200 mm flat wooden pallets. (part 2)

For example, below it shows an 800 x 1,200 mm Euro pallet, which is the most commonly used pallet.

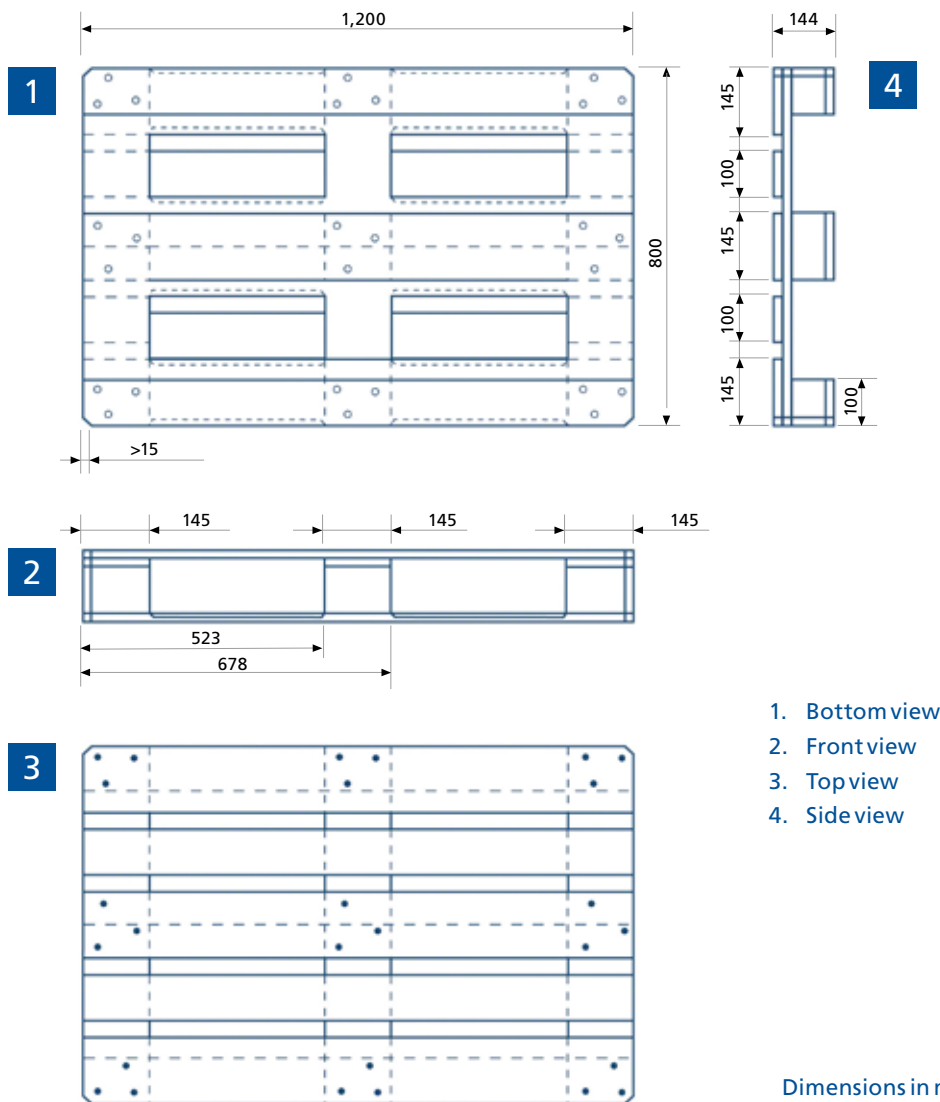

1. Bottom view
2. Front view
3. Top view
4. Side view

Dimensions in mm.

## Inspecting handling equipment

### Equipment in operation

In this section, it lists some general guidelines to keep in mind when operating equipment like a forklift. However, installation users must follow the specific instructions for these types of machines provided by the manufacturer.

The forklift operator must inspect a vehicle's main safety measures each day, checking the condition and operation of:

- the steering system,
- the horn,
- the turning and warning lights,
- reverse gear beeper ,
- general brakes and parking brake,
- the driver retention system (safety belt),
- the structural safety equipment ,
- the forks and the lifting and tipping systems,
- the condition of the tires,
- the oil levels and condition of the battery (cleaned and properly connected,)
- the access area's cleanliness,
- for any warning signs or indications that the machine should be taken out of service.



Check before operating.



Disabled forklift



Parked

If there are any irregularities, report this immediately to your direct superior and stop using the forklift. If the forklift is not working, make sure to label it, describing said problems.

Smoking is prohibited while operating a forklift or while handling the battery.

### Parking

Once you finish operating the forklift, the following must be carried out:

- Park it in the forklift parking zone. Never park it on a ramp or slope.
- Set the parking brake.
- Put the gears in neutral.
- Lower the forks as far as possible.
- Tip the forks forward.
- Stop the motor.
- Safeguard the forklift against improper use. The ignition key must be in the sole possession of the authorised driver, who must remove it when leaving the vehicle.



### Other considerations

**Paint imperfections.** Make note of any damages to the body paint that leave the steel bare, especially in locations with harsh environments.

**Incidents with the racks.** Many incidents that occur with storage systems can create hazardous conditions. As such, we recommend contacting the rack manufacturer immediately, so it can make a quick evaluation of the damage and repair your storage system in order to re-establish the service level to top safety conditions.

The Mecalux Group has a **technical inspection department**, which acts on its own initiative or when contacted by a customer. This department revises installations where the high volume of handling equipment may lead to greater wear of the structural components. It checks that your racks are in proper working condition, and ensures that user safety guidelines are being followed. The Mecalux Group provides its customers with warehouse safety manuals, so that warehouse operators use the racking systems appropriately and safely.

### Validation of handling equipment

Spain has its own regulation (UNE 58014) on the validation of new handling equipment. This validation has three parts, including:

- Documentary validation
- Calculation validation
- Assembly validation.

Date: ..... / ..... / .....

## Safety checklist for live pallet racking and the push-back system

RACK	FRAME NO.	FRONTAL	INNER	FRAMES									
				Type:.....			Height..... mm		Length.....mm				
				Green	Uprights Amber	Red	Diagonals in poor condition	Footplate in poor condition	Anchor bolts in poor condition	Vertical Good    Bad			

RACK	BAY	LEVEL	FRONTAL	INNER	BEAMS				OTHER ELEMENTS IN POOR CONDITION LIVE PALLET RACKS								
					Type:.....		Length..... mm		Rollers	Tracks	Retainers	Bumpers	Brake drum	Brake rollers	Centralisers		
					Green	Amber	Red	Missing locking systems									

OTHER ELEMENTS IN POOR CONDITION PUSH-BACK	
Carriages	Tracks

**COMMENTS**



## HEAD OFFICE - SPAIN

Tel. +34 932 616 913 – info@mecalux.com – mecalux.com

### EUROPE

#### BELGIUM

Tel. +32 2 346 90 71  
info@mecalux.be  
mecalux.be

#### CROATIA

Tel. +386 41 379 122  
pisarna@mecalux.com  
mecalux.hr

#### CZECHIA

Tel. +420 222 524 240  
info@mecalux.cz  
mecalux.cz

#### FRANCE

Tel. +33 01 60 11 92 92  
info@mecalux.fr  
mecalux.fr

#### GERMANY

Tel. +49 (0) 2133 5065 0  
info@mecalux.de  
mecalux.de

#### ITALY

Tel. +39 02 98836601  
info@mecalux.it  
mecalux.it

#### NETHERLANDS

Tel. +31 208 08 30 96  
info@mecalux.nl  
mecalux.nl

#### POLAND

Tel. +48 32-331 69 66  
info@mecalux.pl  
mecalux.pl

#### PORTUGAL

Tel. +351 21 415 18 90  
info@mecalux.pt  
mecalux.pt

#### ROMANIA

Tel. +40 753 098 246  
romania@mecalux.com  
mecalux.ro

#### SLOVAKIA

Tel. +421 220 545 117  
info@mecalux.sk  
mecalux.sk

#### SLOVENIA

Tel. +386 41 379 122  
pisarna@mecalux.com  
mecalux.si

#### SPAIN

Tel. +34 932 616 913  
info@mecalux.es  
mecalux.es  
TurKEY  
Tel. +90 216 706 10 15  
info@mecalux.com.tr  
mecalux.com.tr

#### UNITED KINGDOM

Tel. +44 0121 3336 602  
info@mecalux.co.uk  
mecalux.co.uk

### AMERICA

#### ARGENTINA

Tel. +54 (11) 4006-4444  
info@mecalux.com.ar  
mecalux.com.ar

#### BRAZIL

Tel. +55 19 3809-6800  
info@mecalux.com.br  
mecalux.com.br

#### CHILE

Tel. +56 (2) 2827 6000  
info@mecalux.cl  
mecalux.cl

#### COLOMBIA

Tel. +57 01 8000 423 553  
info@mecalux.com.co  
mecalux.com.co

#### MEXICO

Tel. +52 800 030 0185  
info@mecalux.com.mx  
mecalux.com.mx

#### URUGUAY

Tel. +598 2683-8879  
info@mecalux.com.uy  
mecalux.com.uy

#### USA

Tel. 1-877-632-2589  
info@interlakemecalux.com  
interlakemecalux.com

Mecalux has a presence in more than 70 countries worldwide

Offices in: Argentina - Belgium - Brazil - Canada - Chile - Colombia - Croatia - Czechia - France - Germany  
Italy - Mexico - Netherlands - Poland - Portugal - Romania - Slovakia - Slovenia - Spain - Turkey - United Kingdom  
Uruguay - USA



Mecalux offers its customers a Technical Inspection Service on completion of an installation, as well as yearly inspections, advice and consultancy on damages, modification or expansion of storage systems.

If an accident occurs at your installation, please notify our technical inspection department immediately. We will respond quickly and will properly inspect, identify damages and/or provide repairs to your installation.

We are always in pursuit of the highest quality controls, which has been a cornerstone of how we do business and how we offer better customer care.

