



# Drive-in Pallet Racking

Storage by accumulation: optimal use of available space





## General Features of the Drive-in System

Drive-in racking is designed for the storage of homogenous products. It accommodates a large number of pallets for each SKU.

This system makes better use of the available space both in terms of area and height.

This type of installation is made of a set of racks, which form inner load lanes, with support rails for the pallets. Forklifts enter these inner lanes with the load raised above the level at which it will be deposited.

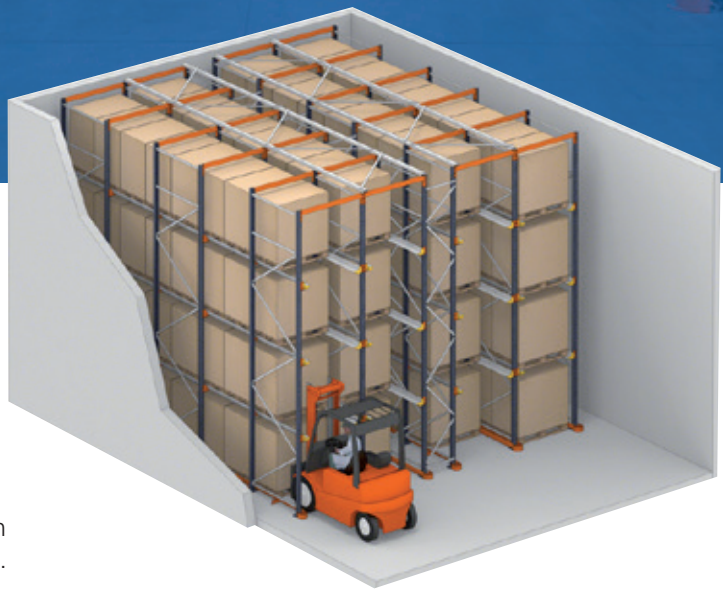

Each load lane has support rails on both sides. These are arranged on different levels, and the pallets are placed on top of them. This racking system is made of extremely robust material, thus making it suitable for storing fully-loaded pallets.





The drive-in system can accommodate as many SKU's as there are load lanes. The number of pallets will depend on the depth and the number of load levels.

It is best to store products with the same SKU in each load lane, to avoid unnecessary pallet manoeuvres. The depth of each lane will depend on the number of pallets per SKU, the space available and the length of time they will be stored.

As shown in the following illustrations, the drive-in system has a greater storage capacity than the conventional pallet racking system. The illustrations show one facility with three different distributions and capacities.

**Pallet rack distribution**

Total storage surface area: 858 m<sup>2</sup>  
Capacity: 306 pallets per level

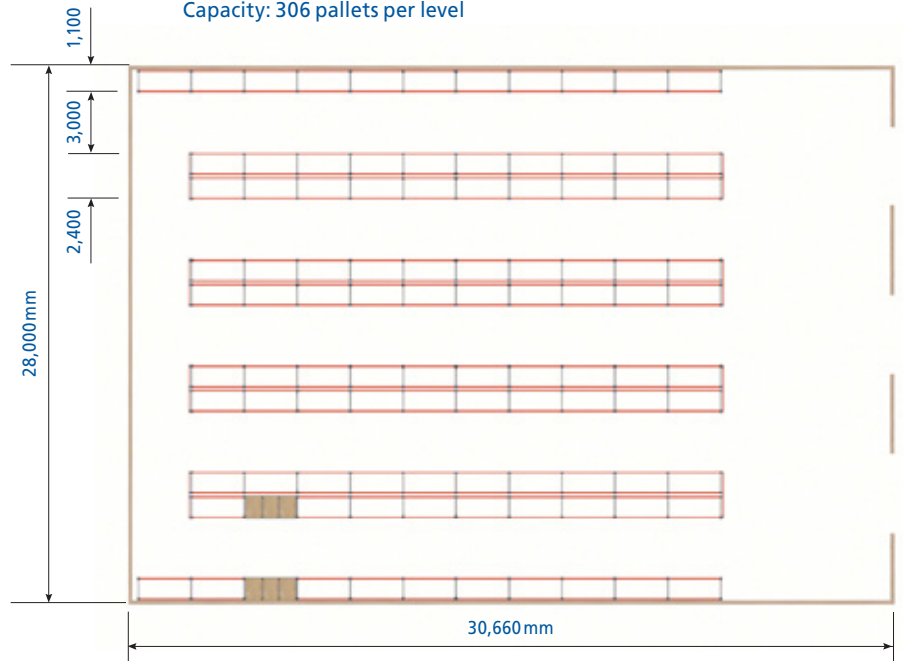

**Drive-in distribution**

Total storage surface area: 855 m<sup>2</sup>  
Capacity: 522 pallets per level

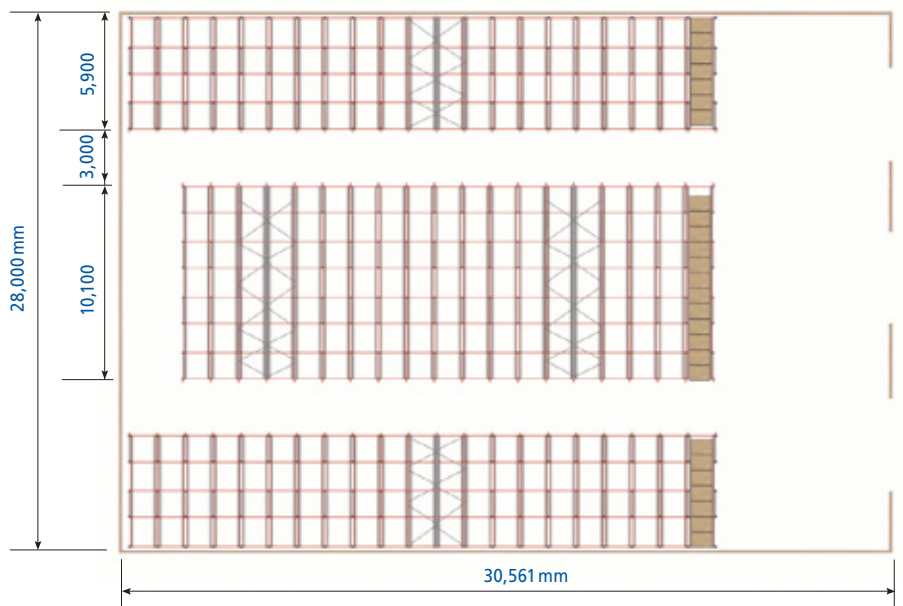



Conventional pallet racking and drive-in systems are usually combined in a warehouse. The drive-in system is used for high rotation products.

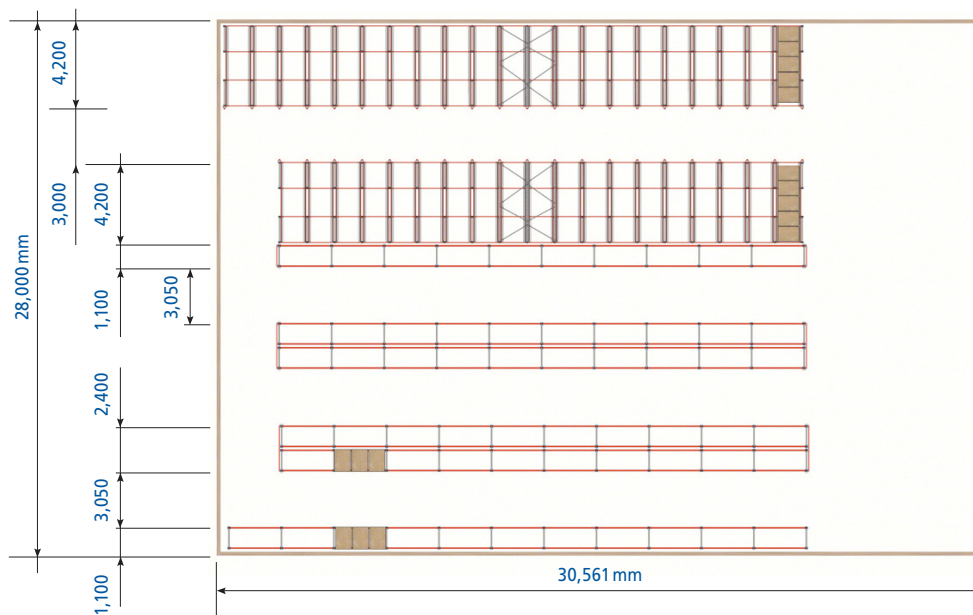

Capacity: 383 pallets per level  
(200 pallets drive-in system,  
183 pallets conventional pallet  
racking)



### Load management for drive-in systems

#### Drive-in

This is the most common way of managing loads in a drive-in system. The racks function like a warehouse depot. There is just one access aisle, from which loading and unloading are carried out in reverse order.

#### Drive-through

In this case, the load is managed using the racks as a buffer warehouse, with two load access points, one on each side of the bays. With this system, it is possible to control production differences, for example, between manufacturing and dispatch, between production phase 1 and phase 2, or between production and loading bays.

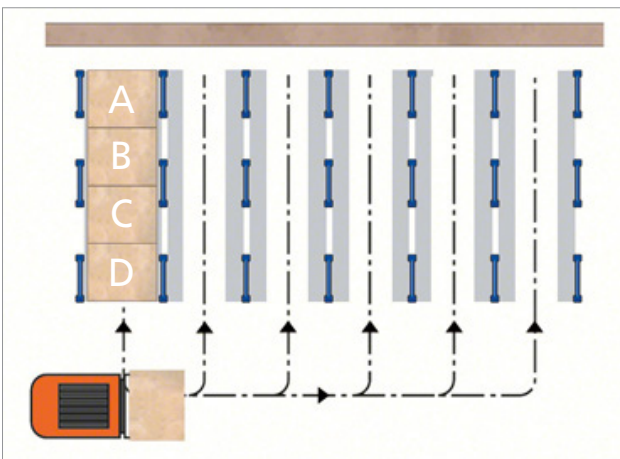

**Loading order:** A,B,C,D  
**Unloading order:** D,C,B,A  
 LIFO system (the first load in is the last one out)

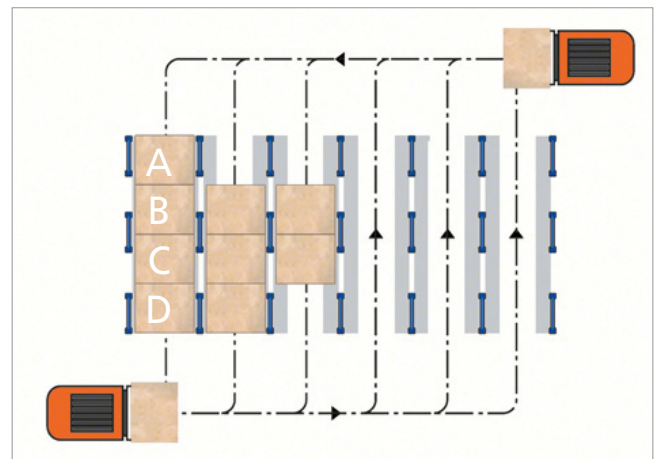

**Loading order:** A,B,C,D  
**Unloading order:** A,B,C,D  
 FIFO system (the first load in is the first one out)



### Forklifts

The forklift enters the storage lanes with the load raised above the level where the load will be deposited. Counter-balanced forklifts and standard reach trucks are the handling equipment used with drive-in systems.

Unlike the conventional system, the pallets are handled perpendicular to their skids. In drive-in pallet racking, the forklift deposits the pallet by resting the pallet skids on the support rails. An extreme amount of pressure is exerted on the skids, so the pallets must be in very good condition.



The following illustrations show the correct way to place the pallets (figure 1).

Pallets can only be placed the other way around if they are durable and rigid enough, and if the weight of the load allows. Moreover, you must check if the forklift can enter the lane.

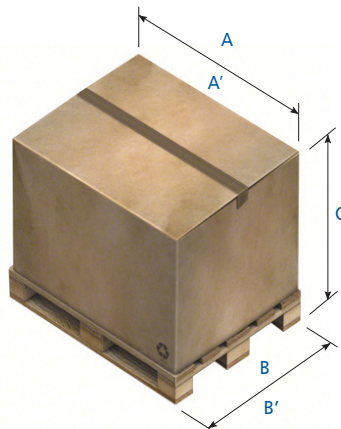

If the load overhangs the pallet, dimensions A and B (the pallet measurements) may be different from A' and B' (the load measurements), which will influence the dimensions of the racks and supports, as shown in the section on Clearances.



Figure 1





Forklifts travel inside the storage lanes. So, the necessary margins must be calculated to create safe work conditions. Specific measurements must be taken into account when designing an installation:

- A. Total width of the forklift. There must be a minimum clearance between the forklift and the vertical elements of the racking bays of 75 mm on each side. Dimension X, the distance between the uprights, must include this space.
- B. Operator's protective structure. A minimum 50 mm of clearance from the support rails is needed (dimension Y).
- C and D. Height of the base and the forklift protectors. Dimension Z and dimension Y must be easy to cross.
- E. Maximum lift height. Must be at least 200 mm greater than dimension W.

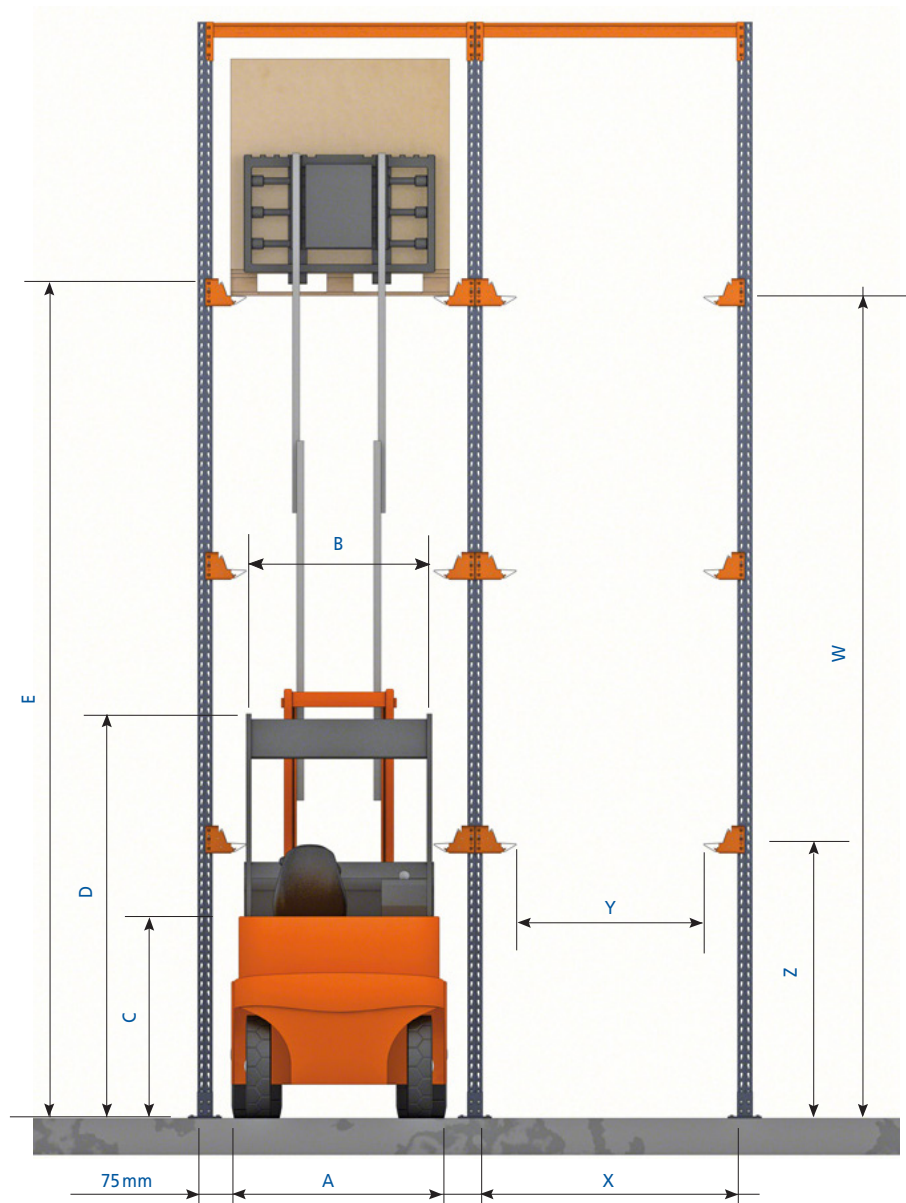



## Calculation principles

### Standards and recommendations

Mecalux calculates drive-in pallet racking with the following main criteria from:

- EN 1993 standard (Eurocode 3)
- FEM Directive 10.2.07 (Design of Drive-in Pallet Racking)

### Calculation criteria

Mecalux uses a powerful calculation programme that implements the most important aspects of the previously mentioned standards and recommendations, such as:

- Safety coefficients for both increasing loads and reducing material.
- Specific load situations for limit conditions and service conditions.
- Minimum pallet support on the 20 mm rail when the unit load is moved, considering the load condition that causes the most deformity to the rack.
- Second order calculation.
- Modelled structure with global and local imperfections.



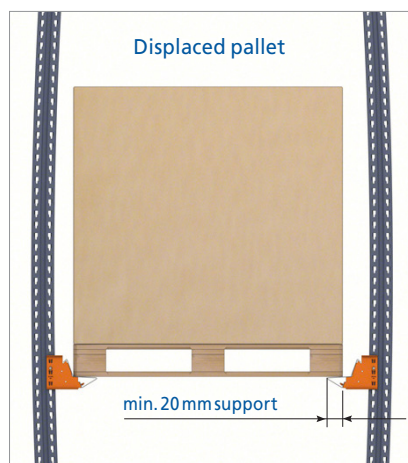
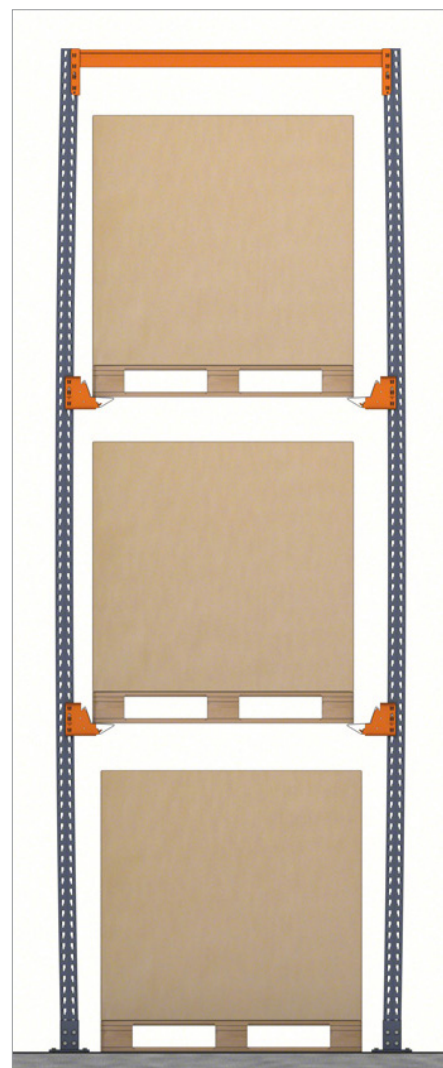

### Maximum deflection of the pallet support rails

The maximum deflection or deformation of the pallet support rail is limited to the distance between supports/200. As these are open profiles with non-symmetrical shapes, the rails are calculated using finite element programmes.

### Safety coefficients

The structural safety of an installation is obtained by adopting the following coefficients:

#### -Weighting coefficients

that increase the actions or loads to be considered. These coefficients vary according to the geographical area.

#### -Reduction coefficients for material

that decrease the characteristics of the materials used. These coefficients vary according to the geographical area.

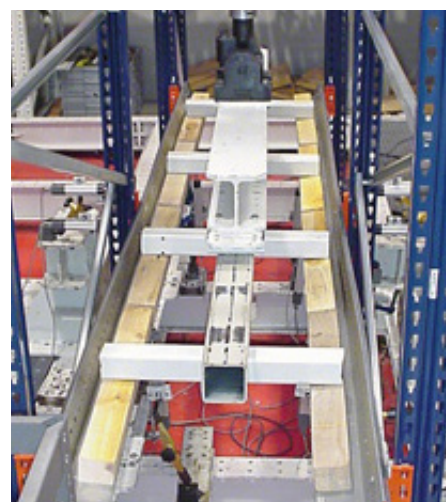

Figure 4. Example of a rail test for drive-in pallet racking.



### Racking stability

The racking bays must provide guaranteed crosswise and lengthwise stability. The lengthwise plane is parallel to the frame, and the crosswise plane is perpendicular to the storage lanes.

### Lengthwise stability

Stability is ensured by the rigidity of the frames and the diagonals, as well as by attaching them to each other by the support rails.

### Crosswise stability

Three basic constructive systems guarantee stability.

### Constructive system 1

Rigidity is obtained by joining the uprights and beams together, as well as the degree of embedding obtained between the feet of the uprights and the floor using two anchors.



Stability of the racks in constructive system 1

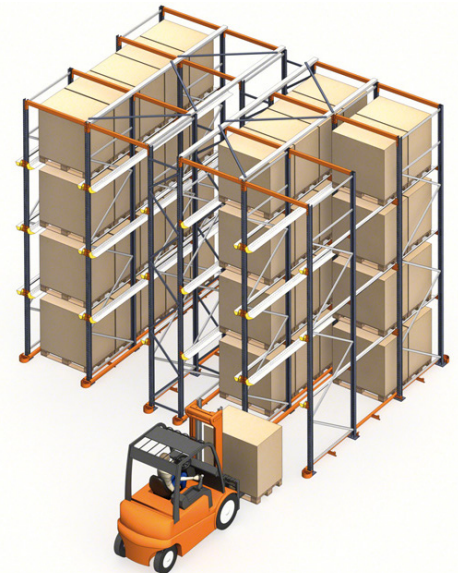

Stability of the racks in constructive system 2 with single or double-entry



### Constructive system 2

In addition to the aspects considered in constructive system 1, rigidising lanes and upper cross braces are fitted that transmit horizontal stresses straight to the floor.

### Constructive system 3

The rigidising lanes are replaced by vertical bracing at the back (in single-entry racks) or in the centre (in double-entry racks).



Stability of the racks in constructive system 3

The choice of constructive system depends on the height of the racking bay, the weight of the pallets, the depth of the lane and their use. Only constructive systems 1 and 2 may be used with drive-through systems.



### Calculating the uprights

The upright is one of the main elements of drive-in racking and, therefore, must be very carefully calculated. Unlike what happens with other storage systems, with these racks the upright is not only subjected to compressive forces but also to flexion, requiring that the upright is provided with the necessary inertia.

Mecalux's calculation programme implements the aspects of Eurocode 3 standard and the FEM Directive 10.2.07.

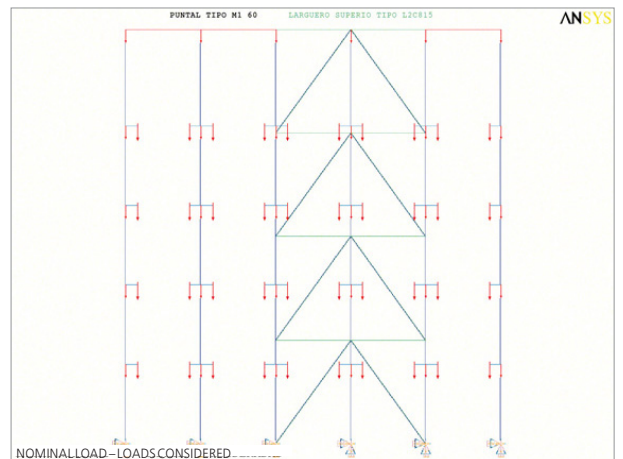
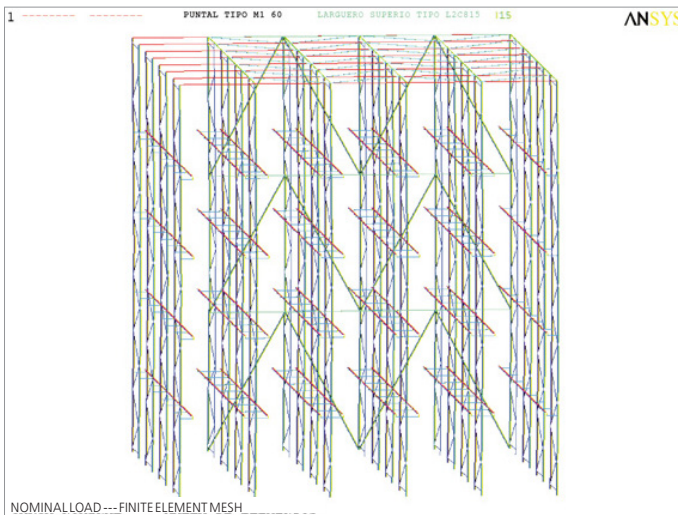
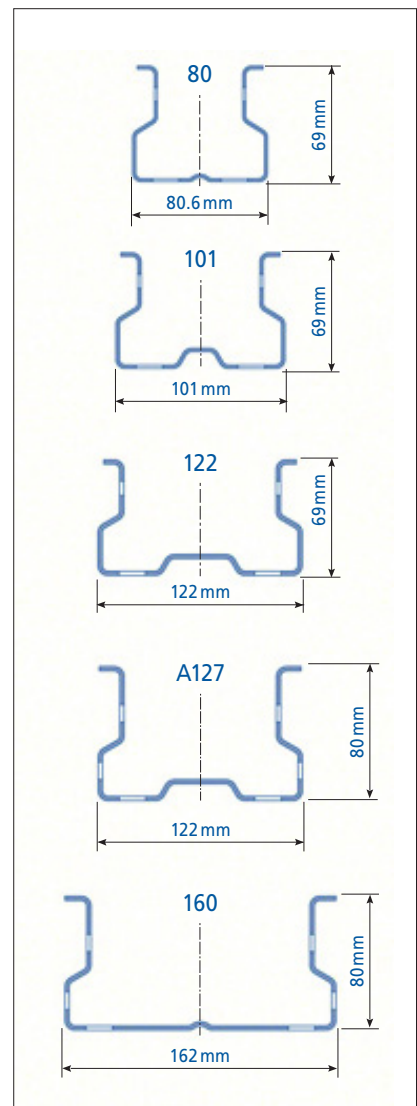
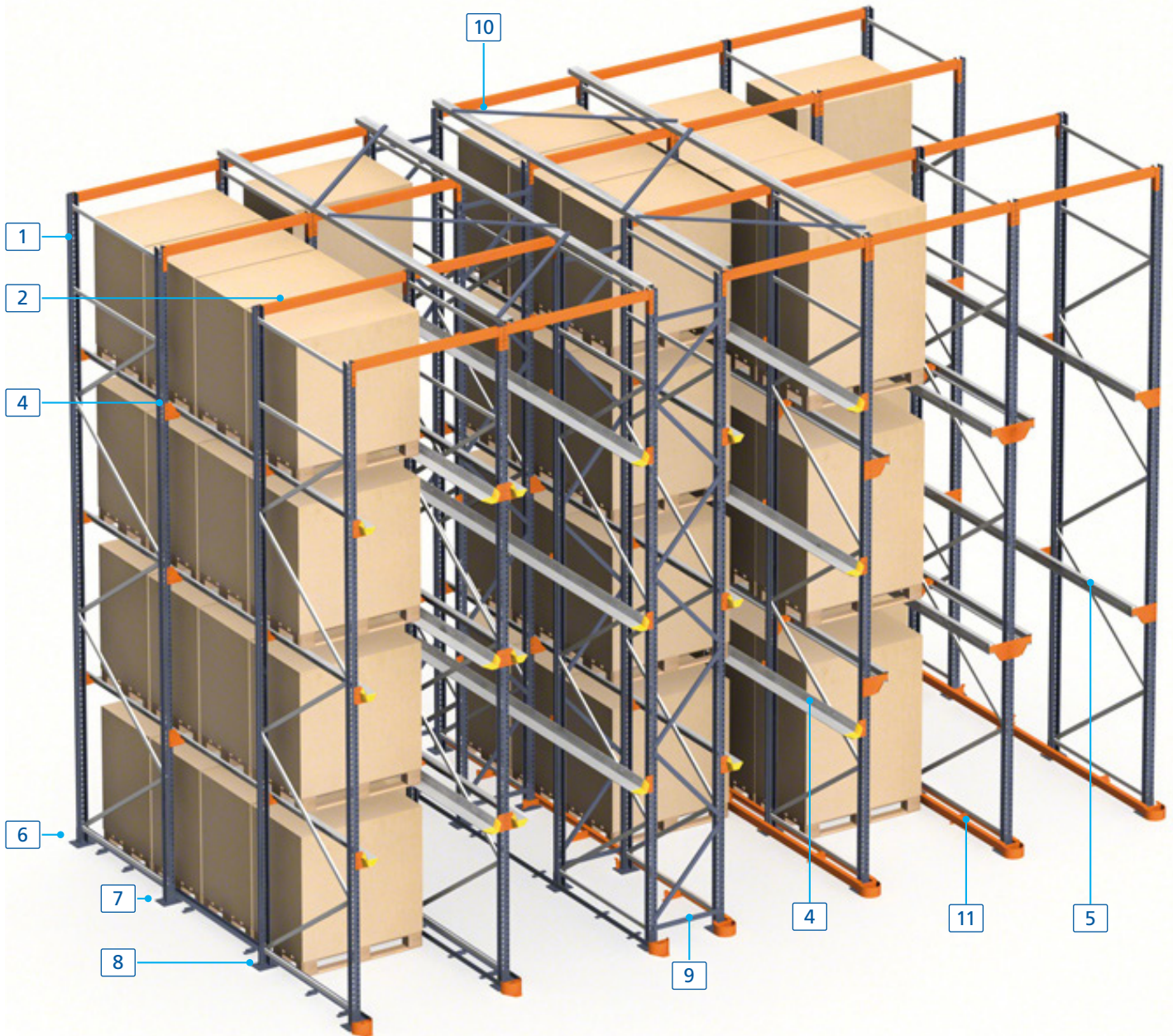

Figure 7. Load combination when calculating the upright



The uprights obtained as a result of these calculations have been developed with geometries that are specific to each type of installation and cover all storage needs regarding the height, load and distribution of the installation (figure 8).

Figure 8. Uprights used



**Basic components**

- |                  |   |
|------------------|---|
| 1. Frame         | 6. Upright footplate                            |
| 2. Drive-in beam | 7. Levelling plates                             |
| 3. Bracket       | 8. Anchor bolts                                 |
| 4. GP rail       | 9. Bracing set (Constructive system 1)          |
| 5. C rail        | 10. Upper cross bracing (Constructive system 2) |
|                  | 11. Guide rail (optional)                       |



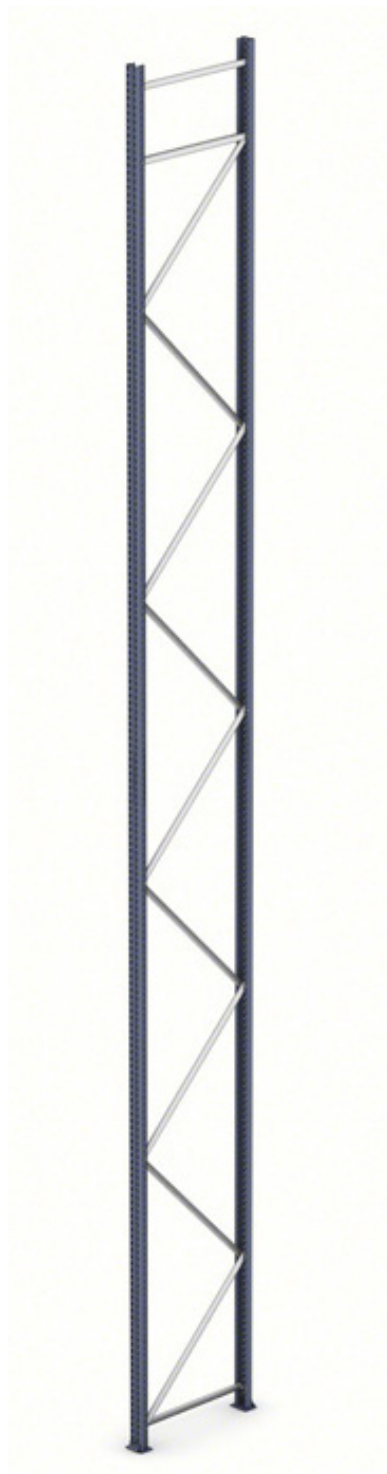

### Frames

Frames are made of two uprights with the corresponding diagonals, footplates and accessories. The frames have slots every 50 mm to accommodate the beams and supports. The depth of the frame is determined by the dimensions of the storage aisle and the height, measurements and weight of the pallets.

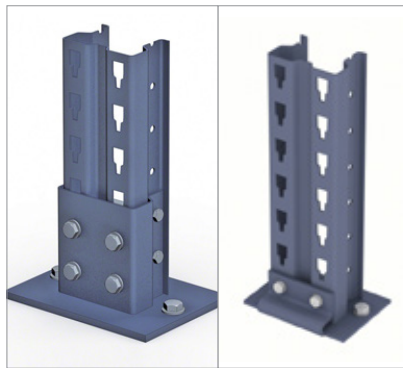

### Upright footplates

As part of the frame, it is designed to be fitted with two anchor bolts and levelling plates.



### Top beams

This connects the frames at the top, forming a gantry.

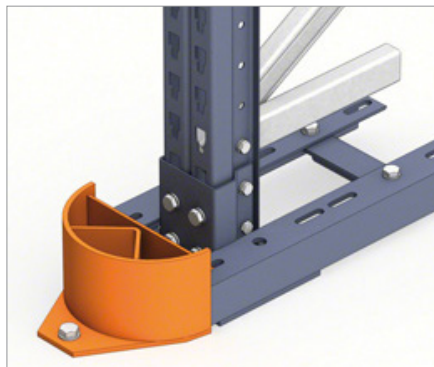

### Guide rails and protectors

These components make it easier for forklifts to move around and reduce the possibility of accidental damage. These can have single or double profiles, depending on the type of forklift used.

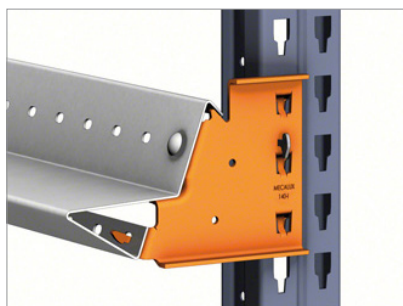

### GP rails

This pallet support profile is made of triangular-shaped galvanised steel. It enables pallets to be centred with minimal loss of vertical space (50 mm). The profiles are supported on and joined to the uprights using GP brackets.



### C rails

These C-shaped, 100 mm high steel sheet profiles provide support to pallets without centralising them. The rails are joined to the uprights by C brackets.

## Constructive systems with GP rails

The GP rail is ideal when all of pallets to be stored are of the same size. This means the merchandise can be centred, preventing the pallets from colliding against the sides of the rack structure.

The fact that the GP support is triangular gives it a very high load capacity, with a loss in height of only 50 mm (the part of the profile that is under the pallet). This means that the space between levels can be reduced, or work clearances increased (figure 1).

The aisle width is determined by the frontal dimension of the pallets, plus the minimum necessary margins. If the load overhangs the pallet, the lane needs to be wider and the

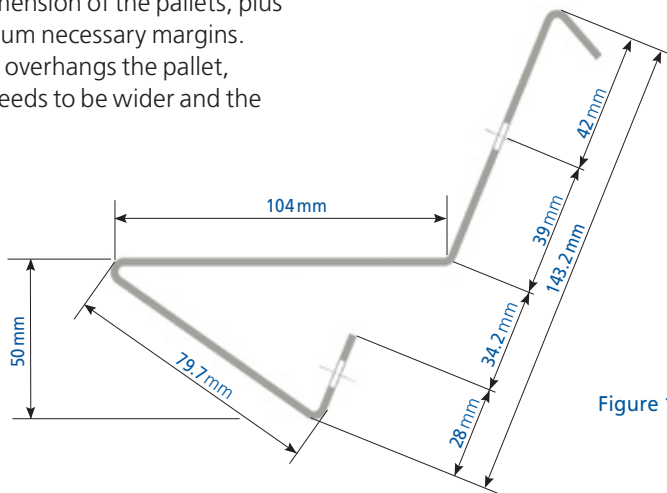

Figure 1

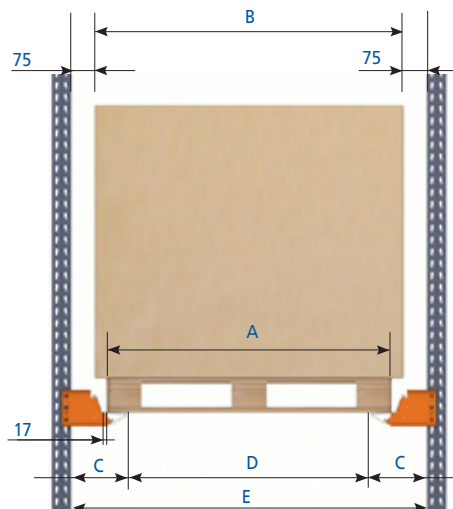

Figure 2. The load overhangs the pallet

supports longer, as a minimum pallet support of 30 mm must be ensured when the pallet is completely displaced to one side (figure 2).

There is a minimum clearance of 75 mm. For tall pallets, we advise increasing this clearance level.

The frontal dimensions are calculated for pallets measuring 1,200 mm along the front. The same criteria must be used for pallets of other sizes.

Frontal dimensions				
A	B	C	D	E
1,200	1,200	162	1,026	1,350
1,200	1,250	187	1,026	1,400
1,200	1,300	212	1,026	1,450
1,200	1,350	237	1,026	1,500
1,200	1,400	262	1,026	1,550

Dimensions in mm



### Height

The minimum required height clearances are as follows:

- F: height of the lower and middle levels = height of the pallets + 150 mm
- G: height of the upper level = height of the pallets + 200 mm
- H: total height = sum of all the levels, as a minimum.

Dimensions F, G and H must always be multiples of 50 mm (figure 3).

### Depths

The minimum depths to consider are the following:

- X: the total depth of all the pallets (including the load's dimension, if it protrudes), plus a 25 mm clearance per unit load, as a minimum (figure 4).

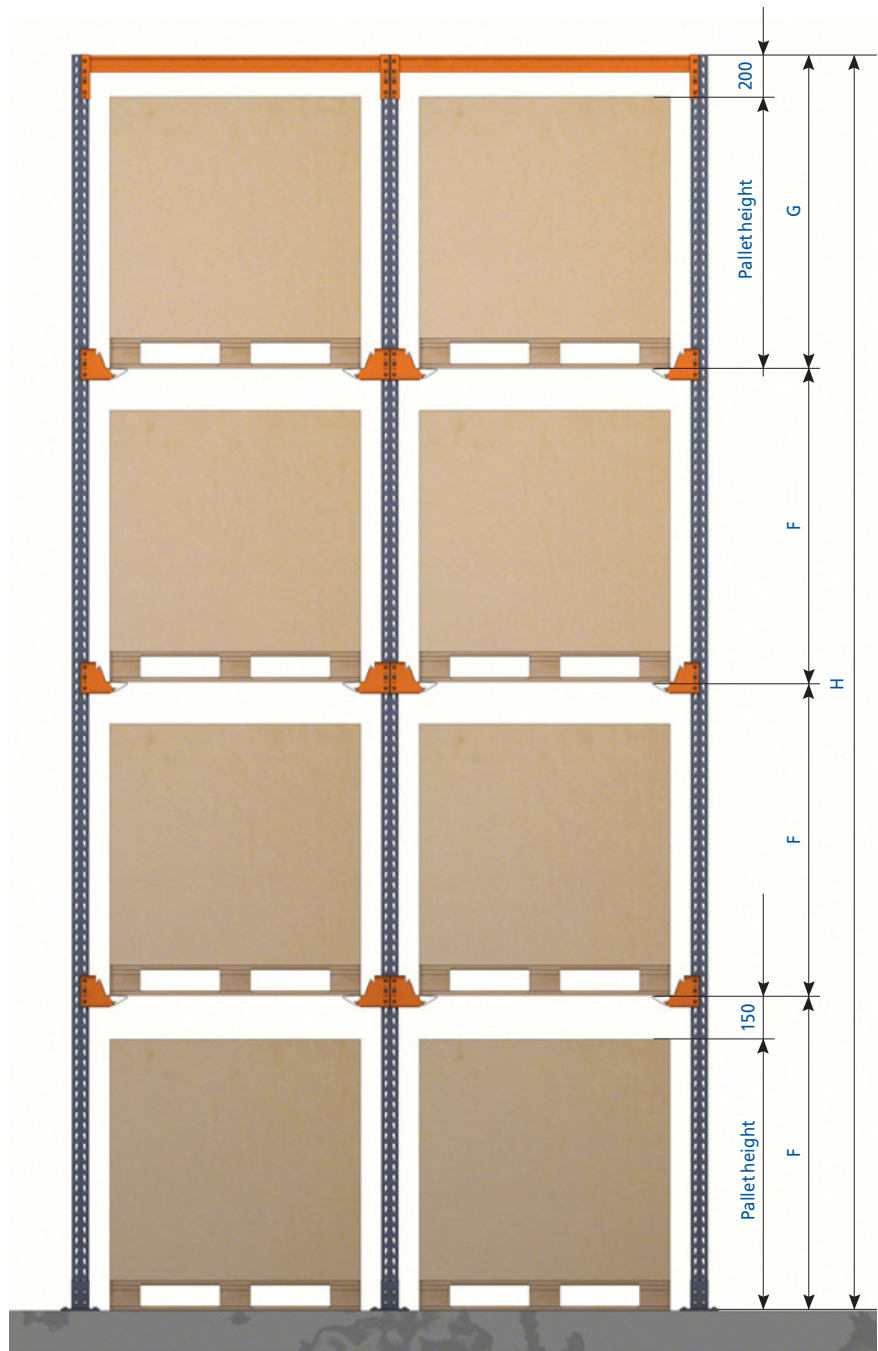

Figure 3

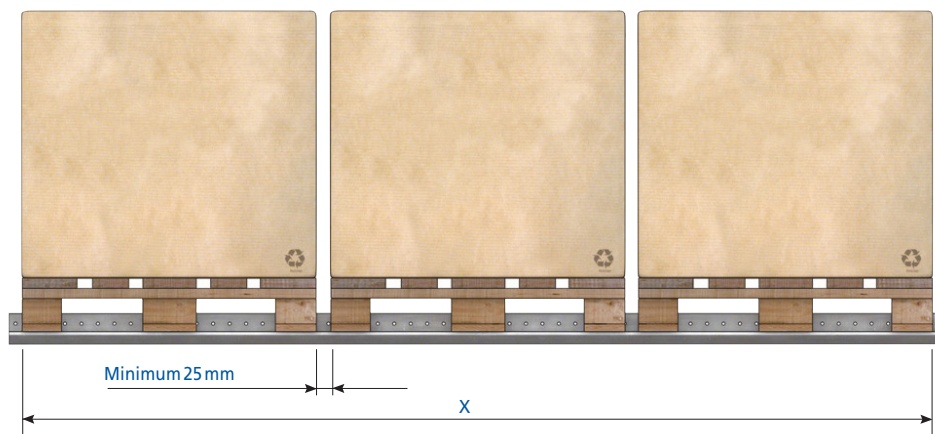

Figure 4



### Constructive systems with C rails

This system is installed when the pallets used have different frontal measurements, and for very large storage units requiring greater support clearances.

C rails do not auto-centralise the different pallets that may be stored in a lane. The system also means that the operators have to be more careful when manoeuvring forklifts (figure 5).

The pallets must be analysed before defining the support measurements.

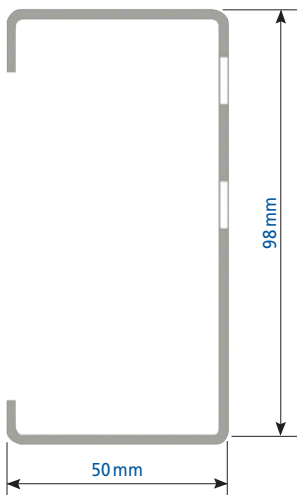
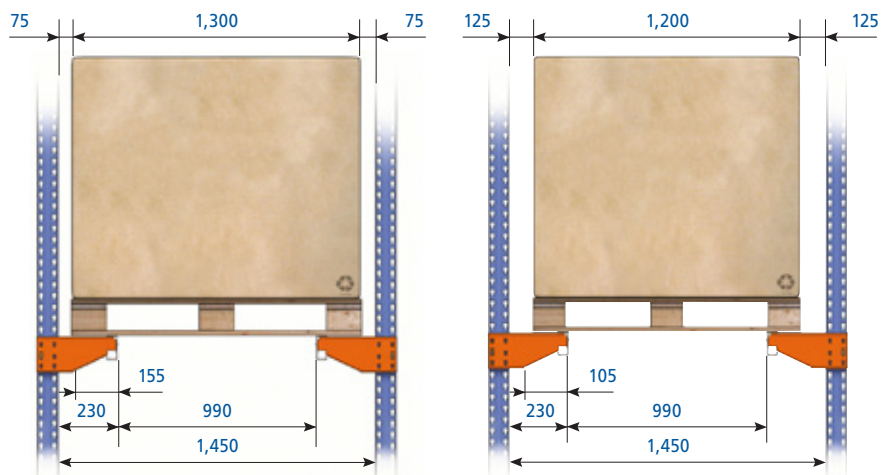

Figure 5

The following illustrations show solutions for storing 1,300 mm and 1,200 mm wide pallets, (where the load does not overhang the pallet in either case).





### Heights

Height clearances to be taken into account are as follows:

- F: height of the lower and middle levels = height of the pallets + 300 mm
- G: height of the upper level = height of the pallets + 200 mm.
- H: total height = sum of all the levels, as a minimum.

Dimensions F, G and H must be multiples of 50 mm (figure 6).

For depth clearances, use the same criteria used with the GP rail (figure 4).

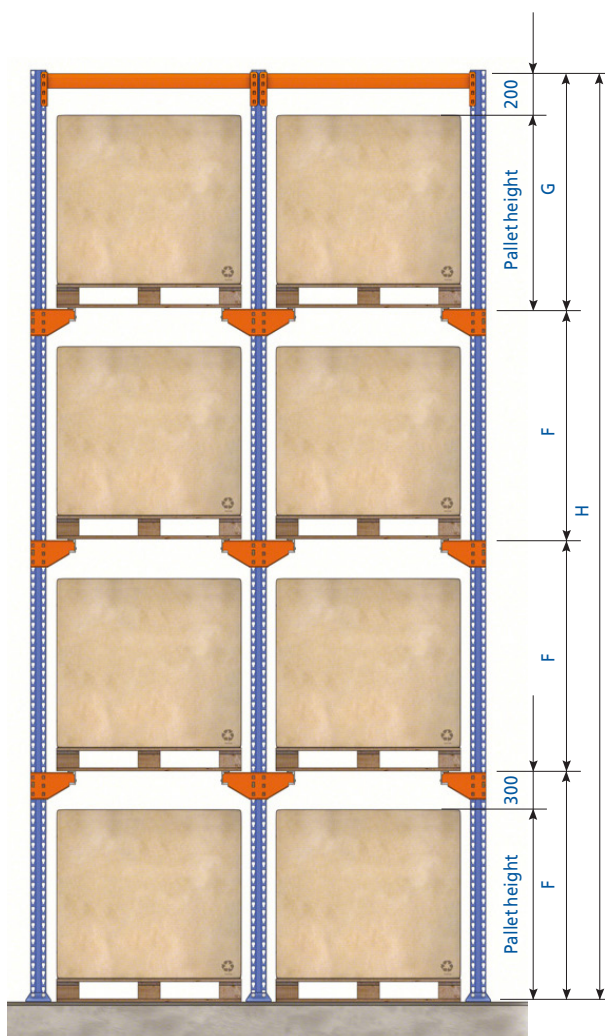

Figure 6



## Lower guide rails

The guide rail system is used to:

- **Prevent the pallets from colliding** with the sides of the racking structure.
- **Enable the forklifts to be equipped with lateral wheels**, so they are centralised when moving inside the storage lanes.
- **Avoid the risk of blows to the racks**, preventing possible damage to the load and simplifying manoeuvres.

Their use is highly recommended whenever lanes are very deep.

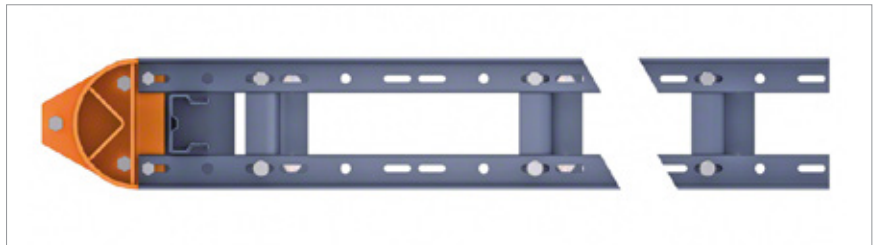

Whenever guide rails are installed, bear in mind that the lane's width is calculated based on the distance the forklift needs to move, plus the width and clearances of the rail profiles.

The most common system is the one which uses LPN50 profiles set on supports that are fixed to the ground, with centralising protectors on the front of the racks. These are joined to the profiles and also anchored to the floor.

This system prevents shocks and vibrations from being transmitted to the racking structure.



Guide rail with LPN profile

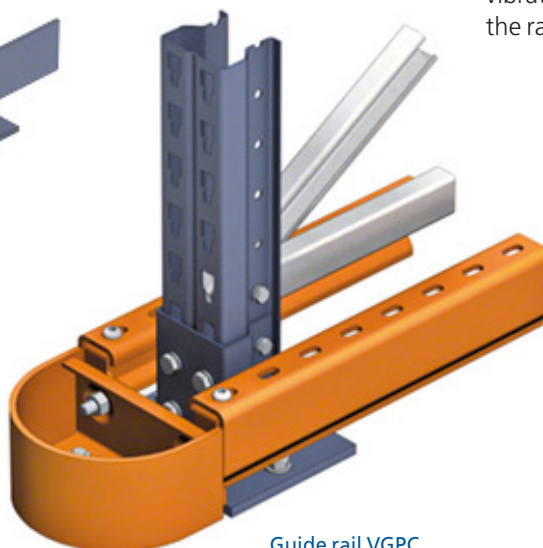

Guide rail VGPC

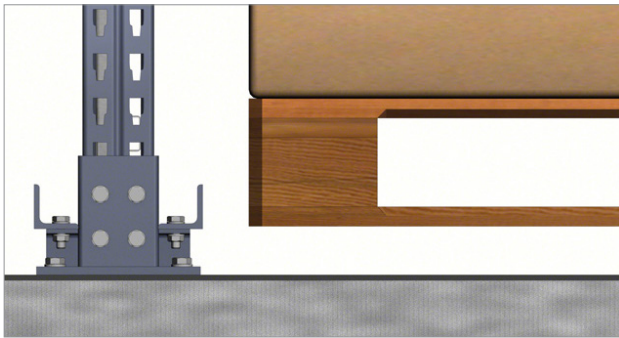

### Single guide profile

The single-profile solution is sufficient when it is only necessary to guide the pallets.



### Guided rail VGPC

These rails are commonly used in warehouses where the forklifts circulating in the drive-in lanes have lateral guide wheels.

The measurements between guides and standard protectors are as follows:

Lane dimensions with standard guides and protectors (in mm)	
X	Y
1,350	1,240
1,400	1,290
1,450	1,340
1,500	1,390
1,550	1,440

X: lane width  
Y: distance between guides

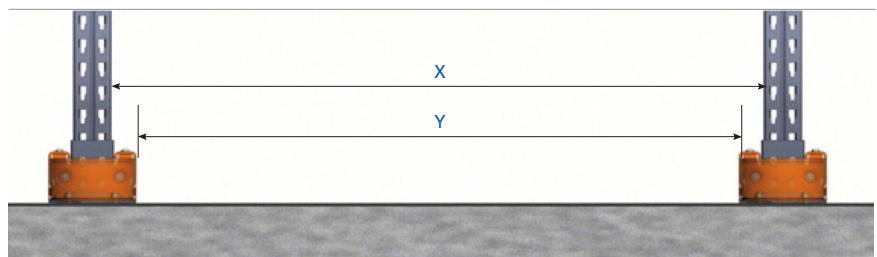

Another guided system has U-shaped profiles placed at the bottom of the racking uprights and fixed to the floor with the same anchor bolts.

This guiding system allows for greater separation between guides for wide-chassis forklifts, without widening the lanes. Front protectors can also be installed.



## Accessories

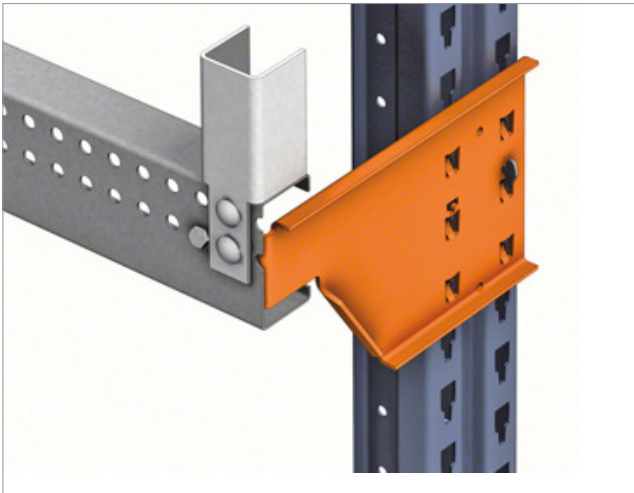

### C rail stop

This stop is installed on C-type load rails to restrain the load and prevent it from protruding.

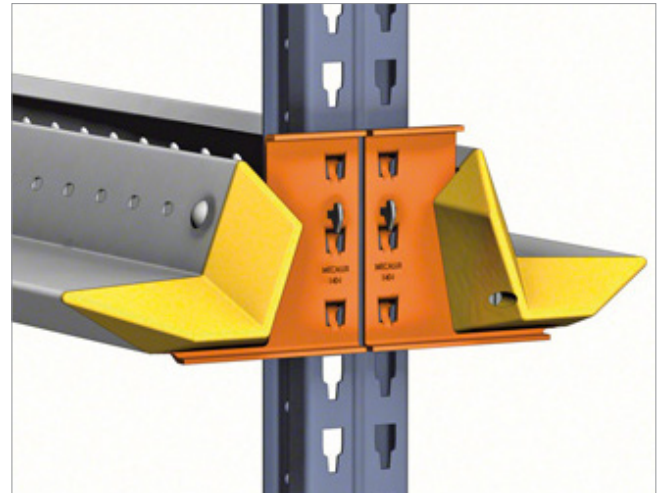

### GP rail centralisers

These are heavy-duty injected plastic parts, which are attached to the front of these rails. They help guide the pallet at the entrance of each lane.





Technical inspection label

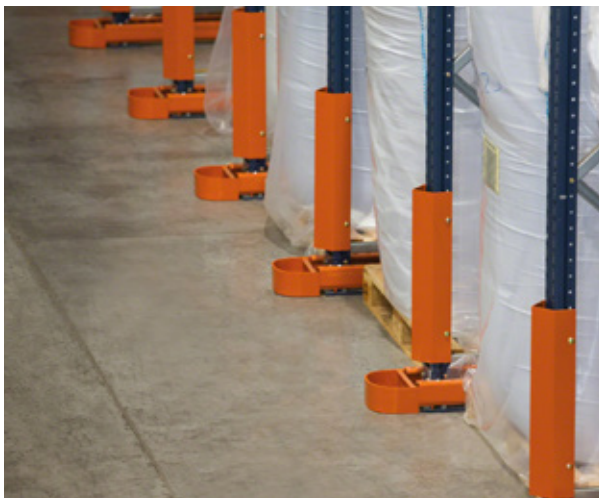

### Upright reinforcers

The first upright of each row of frames has a reinforcer installed at the front, which protects against minor blows.

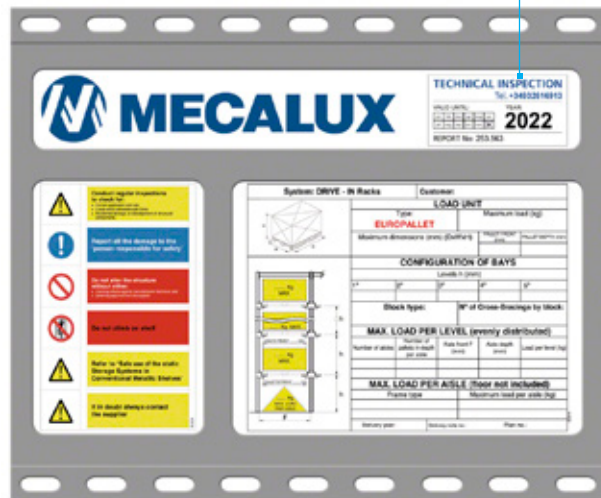

### Safe load warning sign

These plates are used to list the technical specifications of the installation. They are visibly displayed at the end of the racks.

### Technical inspection label

A yearly inspection must be carried out to keep the installation in perfect condition and guarantee long-term safety. The rack manufacturer should be the one to carry out this inspection. Mecalux's Technical Inspection Service provides a report that certifies the condition of the installation and a sticker to put on the Safe load warning notice, which shows the deadline for the next inspection.



### **Cold-storage chambers with a drive-in system**

This storage system is widely used in cold-storage installations –both refrigerated and frozen– where it is essential to maximise space set aside for products stored at a controlled temperature.

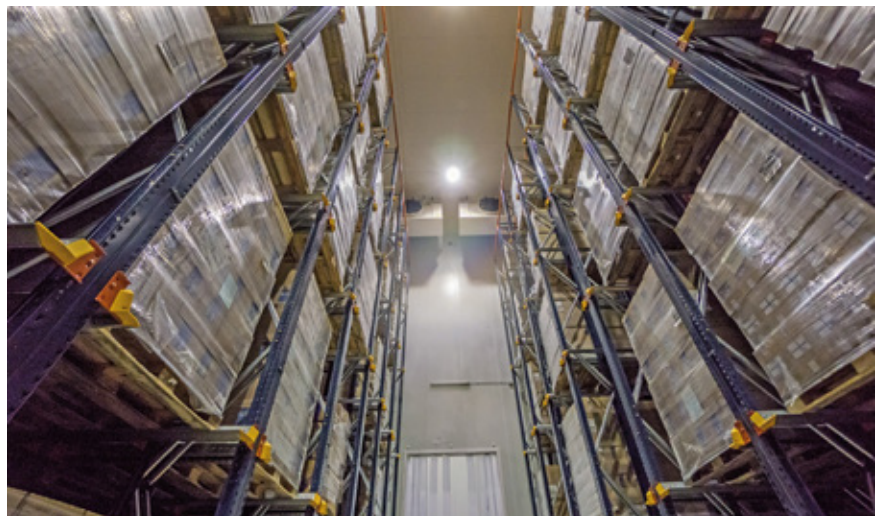



## Clad-rack drive-in warehouse systems

Drive-in pallet racking can also be used to build rack-supported warehouses. The main feature of these warehouses is no pre-existing building is needed, which translates into time and cost savings.

In installations of this type, the racking structure supports its own weight, the weight of the products stored in them and the corresponding

additional forces, just like a traditional warehouse. In addition, they support the weight of the structure and protect against external forces (wind, snow, etc.).

These warehouses can be designed to store products at an ambient temperature or as cold-storage installations.

### Components

1. Drive-in pallet racking
2. Trusses
3. Roof joists
4. Facade joists
5. Facade cladding
6. Roof cladding
7. Watertight wall

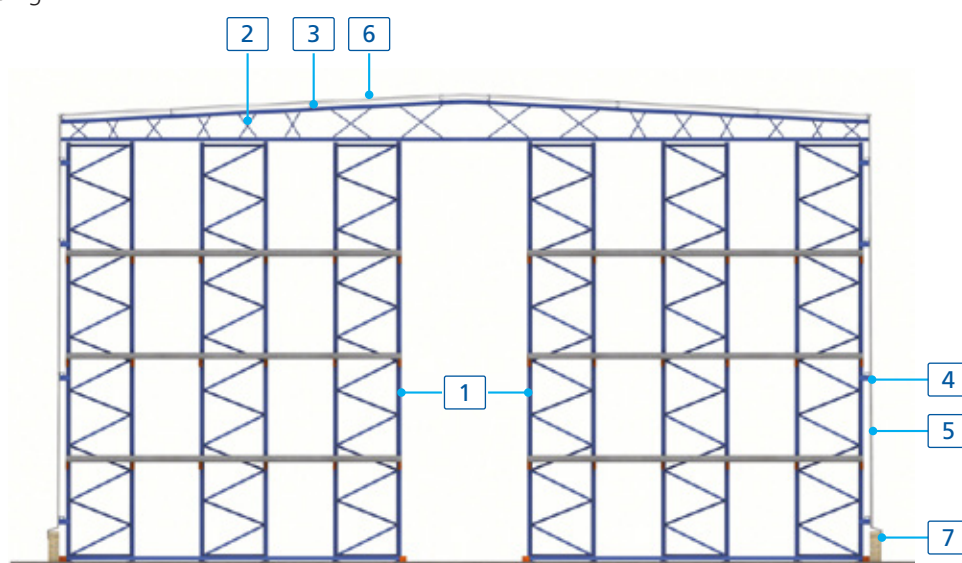





## Automated drive-in warehouse systems

This system can be automated, including stacker cranes and using Pallet Shuttles to move through the channels. This equipment, run by the warehouse management system, is tasked with inserting and extracting the pallets automatically.

A transfer car with a Pallet Shuttle can also be installed as a unit on each level, considerably increasing the number of pallets moved.

Installations of this type need to be studied in great detail. For further information, we recommend you speak to our technical and sales department.



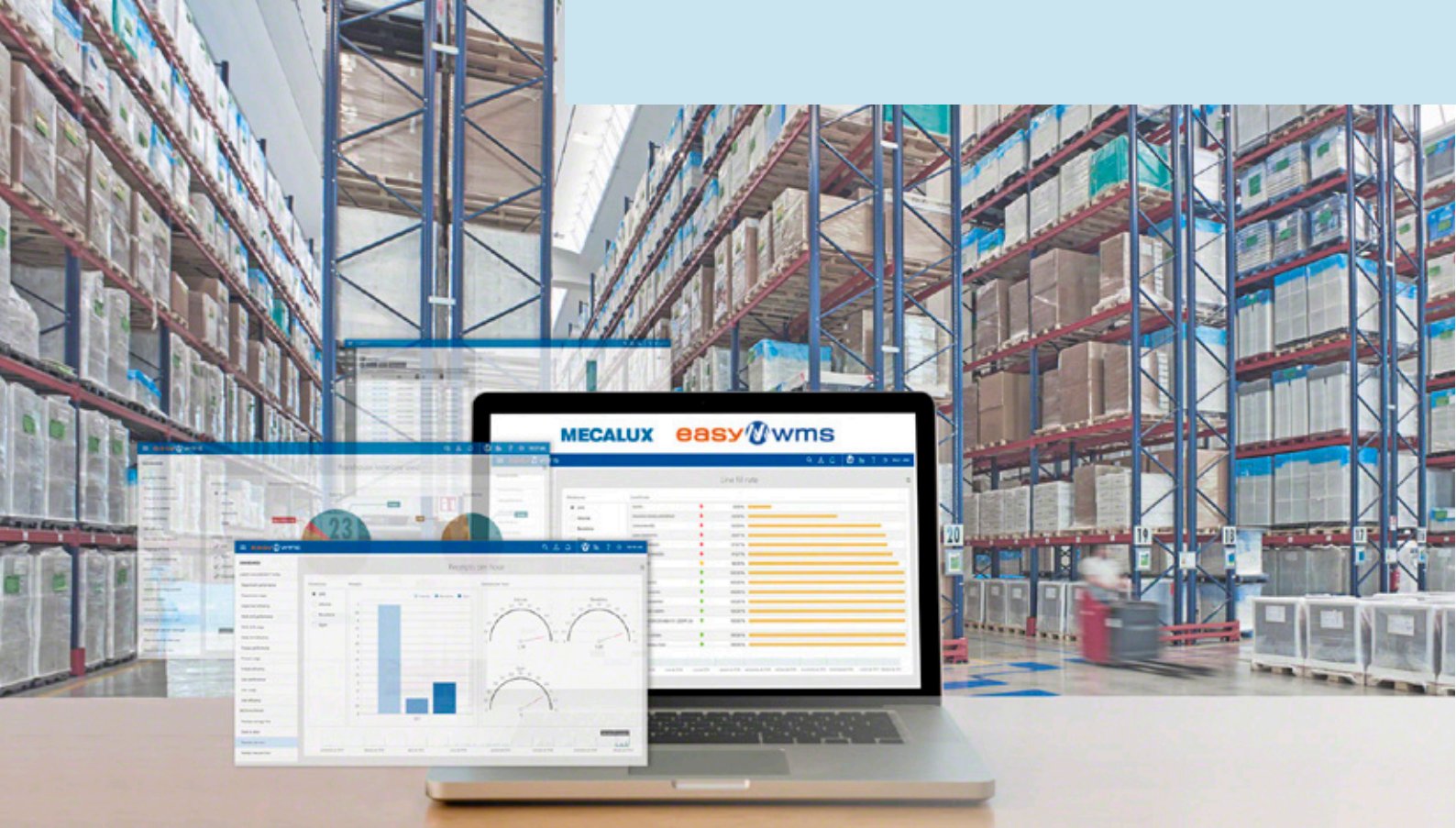

## Easy WMS Warehouse Management System

The brain of the installation

Easy WMS is a powerful, versatile, scalable and flexible software program that can manage a manually operated warehouse (paper or radiofrequency device run), a mixed facility or a large automated warehouse with the same efficiency.

Use it to streamline physical product flows and document management, from warehouse inputs to dispatches, for guaranteed full end-to-end traceability.

### Advantages

- > Receive real-time stock control
- > Lower logistics costs
- > Increase storage capacity
- > Reduce handling tasks
- > Eliminate errors
- > Get precise, high-speed picking
- > Adapt to new ecommerce needs
- > Manage omnichannel operations
- > Achieve a fast ROI (in 12-18 months)



Mecalux works with leading suppliers that attest to the quality, reliability and technical level of the Easy WMS platform:



# Interconnected solutions for your supply chain



## WMS for Ecommerce

Ensures efficient multichannel logistics. Optimises the logistics operations of online shops, regardless of their size, number of daily orders or storage capacity.



## Multi Carrier Shipping Software

Automates product packaging, labelling and shipping. Coordinates direct communication between the warehouse and the various transport agencies.



## Store Fulfillment

Synchronises inventory and workflows to ensure optimal stock management between the central warehouse and the network of brick-and-mortar shops.



## WMS for Manufacturing

Facilitates traceability in manufacturing processes. Guarantees the continuous supply of raw materials to the production lines.



## Supply Chain Analytics Software

Analyses the thousands of pieces of data generated daily in a warehouse, allowing the manager to make strategic decisions based on the real throughput of operations.



## Marketplaces & Ecommerce Platforms Integration

Synchronises the stock in the warehouse with the online catalogue in real time. Easy WMS automatically connects to the main digital sales platforms and marketplaces such as Amazon, eBay and PrestaShop.



## 3PL Warehouse Management Software

Manages billing between a 3PL and its customers. A dedicated access platform provides information on stock condition and how to place orders or request customised shipments.



## Labor Management System (LMS)

Maximises operational productivity. It objectively measures the throughput of operators, detecting opportunities for improvement for the company.



## Warehouse de Slotting Software

Optimises slotting management in the warehouse. DIT determines the optimal slotting for each SKU based on a set of predetermined rules and criteria (historic, current and future demand).



## Yard Management System

Supervises the movement of vehicles in the yard at the warehouse or distribution centre. Optimises loading dock operations to improve vehicle flow and avoid bottlenecks with entering and exiting goods.

## Easy WMS in the cloud

- » **Lower initial investment** since in-house servers are not needed.
- » Faster, simpler **implementation**.
- » Easier, more affordable **technical support and maintenance**. Total security with Microsoft Azure.
- » Software **version up-to-date** at all times.
- » **Maximum availability** to guarantee business continuity.
- » **Fees adapted** to the needs of each business.



**HEAD OFFICE - SPAIN** - Silici, 1 - 08940 Cornellà de Llobregat - Barcelona  
**Tel. +34 932 616 913 – info@mecalux.com – mecalux.com**

**EUROPE**

**BELGIUM**

Tel. +32 2 346 90 71  
info@mecalux.be  
**mecalux.be**

**CZECHIA**

Tel. +420 222 524 240  
info@mecalux.cz  
**mecalux.cz**

**FRANCE**

Tel. +33 01 60 11 92 92  
info@mecalux.fr  
**mecalux.fr**

**GERMANY**

Tel. +49 (0) 2133 5065 0  
info@mecalux.de  
**mecalux.de**

**ITALY**

Tel. +39 02 98836601  
info@mecalux.it  
**mecalux.it**

**NETHERLANDS**

Tel. +31 208 08 30 96  
info@mecalux.nl  
**mecalux.nl**

**POLAND**

Tel. +48 32-331 69 66  
info@mecalux.pl  
**mecalux.pl**

**PORTUGAL**

Tel. +351 21 415 18 90  
info@mecalux.pt  
**mecalux.pt**

**SLOVAKIA**

Tel. +421 220 545 117  
info@mecalux.sk  
**mecalux.sk**

**TURKEY**

Tel. +90 216 706 10 15  
info@mecalux.com.tr  
**mecalux.com.tr**

**UNITED KINGDOM**

Tel. +44 0121 3336 602  
info@mecalux.co.uk  
**mecalux.co.uk**

**AMERICA**

**ARGENTINA**

Tel. +54 (11) 4006-4444  
info@mecalux.com.ar  
**mecalux.com.ar**

**BRAZIL**

Tel. +55 19 3809-6800  
info@mecalux.com.br  
**mecalux.com.br**

**CHILE**

Tel. +56 (2) 2827 6000  
info@mecalux.cl  
**mecalux.cl**

**COLOMBIA**

Tel. +57 01 8000 423 553  
info@mecalux.com.co  
**mecalux.com.co**

**MEXICO**

Tel. +52 (664) 647 22 00  
info@mecalux.com.mx  
**mecalux.com.mx**

**URUGUAY**

Tel. +598 2683-8879  
info@mecalux.com.uy  
**mecalux.com.uy**

**USA**

Tel. 1-877-632-2589  
info@interlakemecalux.com  
**interlakemecalux.com**

